

# IT MAKES \$ENSE

to buy a new ProTwin

**PROGRAM EXTENDED TO SEPT. 30**

**The Industry-Leading Side-Discharge Spreader Just Got Better**

- Through-Hardened Universal Hammers
- Hydraulic Deflector Now Standard
- Redesigned Front Oil Bath Door
- New Hydraulic Slurry Lid (8118 & 8124)
- Heavier Sectional Flighting (8118 & 8124)
- Heavier Bottom Hoppers (8118 & 8124)
- . . . and much more!

www.kuhnknight.com

**KNIGHT**

Brodhead, WI • Phone 608-897-2131  
Greeley, CO • Phone 970-351-0444

World-Wide Leader in Innovative Manure Spreaders!

## 10¢/GALLON DISCOUNT on the ALL NEW 8100 SERIES PROTWINS

Take this discount coupon to your local dealer. After you've made your best deal on an 8100 Series ProTwin, your dealer will send this coupon to Kuhn Knight. **YOUR DISCOUNT FROM KUHN KNIGHT IS WORTH:**

- \$143 on 8114 • \$182 on 8118 • \$242 on 8124
- \$325 on 8132 • \$406 on 8140

OFFER RUNS JUNE 15 - SEPTEMBER 30, 2003

ONE COUPON PER CUSTOMER PER UNIT • COUPON HAS NO CASH VALUE

Sales & Service

**ROVENDALE AG & BARN EQUIP.**

WATSONTOWN, PA 17777

570-538-9564 OR 570-742-4226

Exit 31, I-80 to I-180 Watsonstown Exit

Hours: Mon.-Fri. 8 to 5; Sat. 8 to 12



## We Move Your World

MEET THE WORLDS MOST ADVANCED LINE OF INDUSTRIAL DIESEL ENGINES

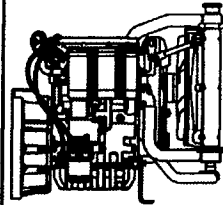

### Deutz FM1000F

Compact, lightweight power packs. Small-bore, overhead cam design for smooth high speed operation up to 3600 RPM. Power updated

8-40 Hp in 2,3,4, & 4-Turbo configurations

### Deutz FL2011 Oil/Air Cooled

Smaller - Smoother - Quieter. Extremely adaptable. Available in oil cooled or air cooled. Over 750,000 units in service worldwide. Compact, installation - friendly package.

20-75 Hp in 2,3,4, & 4-Turbo configurations

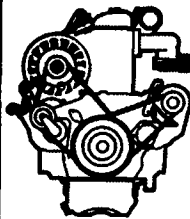
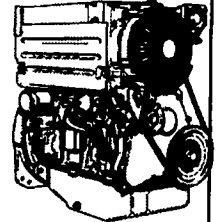

### Deutz FL913/914 Air-Cooled

The Legend Lives

Severe duty engines. Stubbornly reliable - known survivors - Field repairable. Unmatched portability. Redesigned for more power. They just get better and better.

35-192 Hp in 3,4,5 & 6 cylinder

### Deutz BFM2012/1013 Liquid-Cooled

Clean - Quiet - Proven

Extremely fuel efficient. Designed from the ground up to meet all proposed emissions standards. Available with integrated radiator or conventional radiator. Enclosed power units available.

100-300 Hp in 4 & 6 cylinder

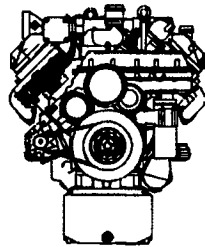
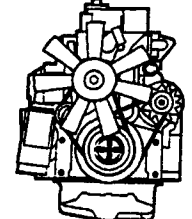

### Deutz FM1015 Liquid-Cooled

Big - Clean - Quiet

Extremely fuel efficient. Compact V-design. Big engine features, individual cylinder heads & 4-valves per cylinder. Deutz quality at a competitive price. V6 and V8 configuration.

276-705 Hp

### Deutz Quality at competitive prices. Extensive product support available.

- New! Deutz 3-year limited warranty.
- Gen-Pak power unit engines from 30 to 700 Hp.
- Industrial & Pump power unit engines from 8 to 600 Hp.
- Deutz meets EPA emissions requirements without electronic ECU on most models.

### AUTHORIZED DISTRIBUTORS FOR PA



**Stuffer Diesel Inc.**  
**Stadco**

**Home Office**  
PO Box 586  
46 Pleasant Valley Rd  
Ephrata, Pa 17522  
Ph 717-738-2500  
Fax: 717-738-2550

**Branch Office (Pittsburgh Area)**  
55 Billot Avenue  
Irwin, PA 15642  
Ph 724-864-6969  
Fax 724-864-9392

Email: mail@staufferdiesel.com Website: www.staufferdiesel.com

S88 03 rev 5/03



# WENGBERS OF MYERSTOWN

TRACTOR PARTS

1-800-451-5240

WWW.WENGBERS.COM

**A Leader in Tractor Parts Since 1958**

814 S. COLLEGE ST. (ROUTE 501)

MYERSTOWN, PA 17067

PRICES GOOD SEPT. 15 THRU 20, 2003

## NEW 3 POINT HITCH ASY.

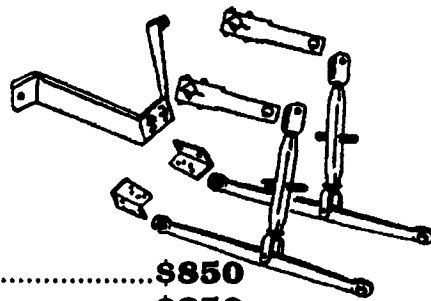

IH Hitch/cyl/N with cylinders	Fits	Price
JD Hitch/N	IH H-560	\$850
JD Hitch 530630	JD A-70	\$650
AC S086/N Conv.	JD 530,630	\$650
AC S087/N	AC WD45	\$650
HK16782	AC D14-D17	\$650
	OL77-880	\$890.50

## TUNE-UP KITS

**Most Makes & Models in Stock**

Carburetors, Dist. Caps, Voltage Reg. Coils, Spark Plugs, Spark Plug Wires

## NEW EMBLEMS & DECALS

~~FARMALL CUB~~

Model	Part	Price
SA, SC, C	352580R/N	\$9
Cub	362387R/N	\$25
SM	357650R/N	\$20
Cub Side Emblem 100, 200	362386R/N	\$100
	362504R/N	\$19

### DECALS

Model	Part	Price
Early Cub Circle Cub Ring	IHC Cub	\$35 Decal
SH	IHCubD	\$40
Super JWD9	DIHCSH	\$30
	MDSWP9	\$26.25

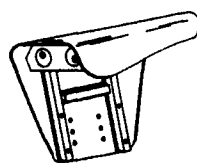

**John Deere & IH NEW FENDERS In Stock**

Model	Price
IH 706-1206 LH/RH Flat Top	\$300 Each
IH A-B	\$135 Each
IH H-450	\$80 Each
JD 4010-4020 Flat Top	\$175 Each
JD A-B-50-730 29" Tall	\$150 Each
JD A Used Orig. Pair	\$600 pr.