

HOUSE

We would like to show appreciation for your patronage by inviting you to our OPEN HOUSE. There will be company representatives present to receive your comments and questions on their equipment.

MANURE HANDLING EQUIPMENT

NDA
 ay, Feb 12,
 y, Feb 14
 Registration
 ing Seminars
 Mixer Demo

ON PARTS
 use



ERD™
EEDERS
 Series
 t



RO Mixers



812 43 bu.

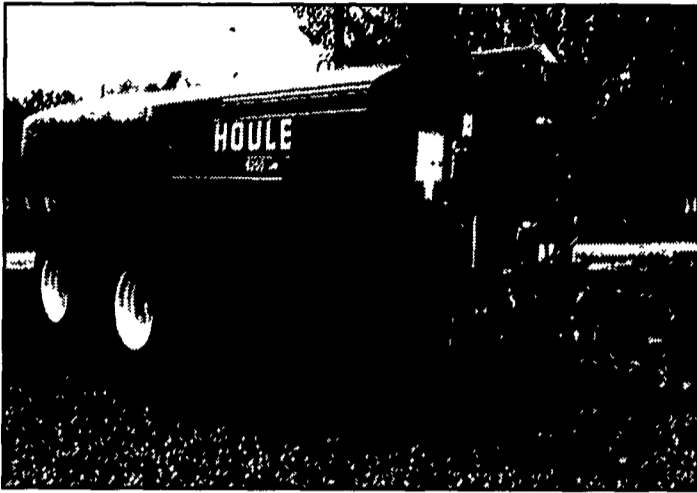

HOULE Tank Spreaders

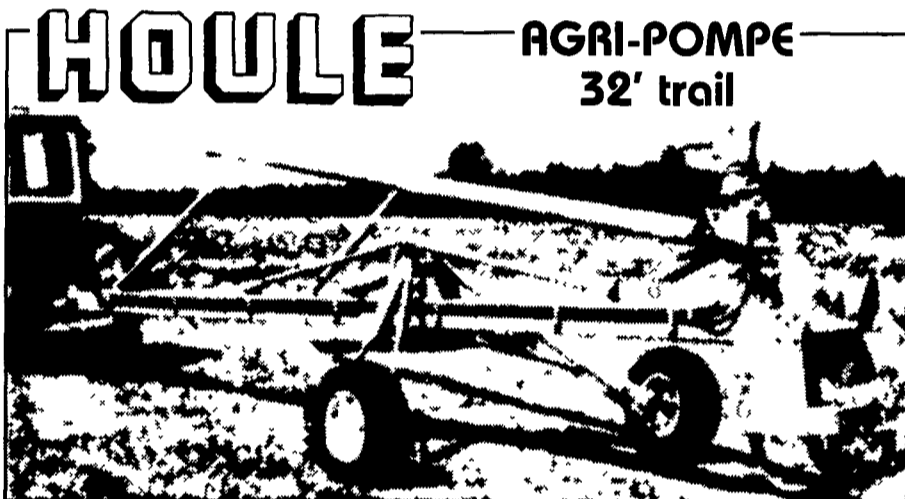

**MANURE HAPPENS?
 PATZ CLEANS IT UP!**

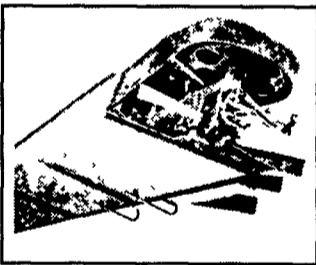

**Gutter Cleaners
 & Alley Scrapers**

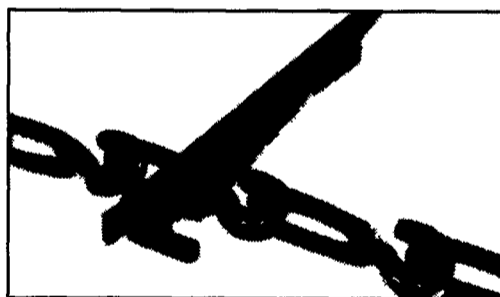

PATZ Gutter Chain

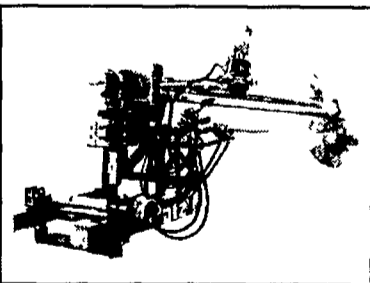

**PATZ Vertical
 Pumps**

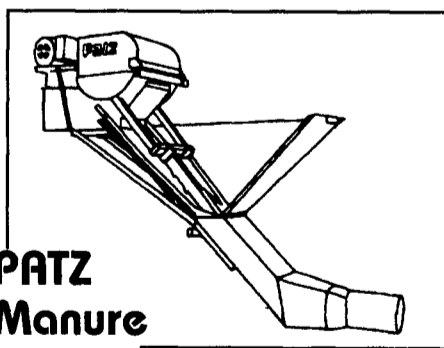

**PATZ
 Manure
 Pumps**

See us also for

HOULE Alley Scrapers

FUTURO

SIMPLE EFFICIENT VERSATILE

**POSITIVE DISPLACEMENT HYDRAULIC
 UNDERGROUND TRANSFER PUMP
 FOR SEMI LIQUID FREE STALL MANURE**

FUTURO installed in reception pit to siphon liquid manure without hopper or suction tube.

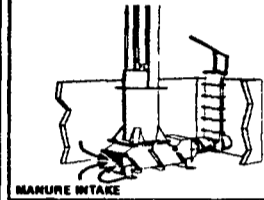

FUTURO installed in a second reception pit to remotely siphon liquid manure using a 16" suction steel tube.

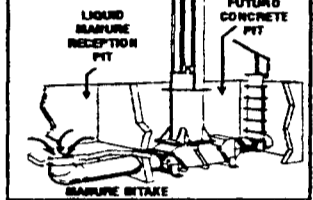

FUTURO installed in concrete pit with hopper

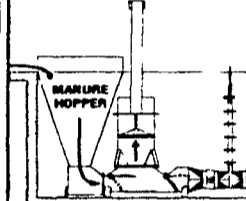

SPECIFICATIONS

- Stainless steel pumping tube with 19" piston and urethane gaskets lubricated with oil
- Intake and exhaust flappers simply actuated by vacuum and pressure of manure
- Flappers mounted on stainless steel shaft and brass bushings with remote grease lines
- Safety manual guillotine door
- Capacity 5 or 7 cows minute
- 12" Ø PVC evacuation pipe

See the New PATZ MANURE SEPARATOR

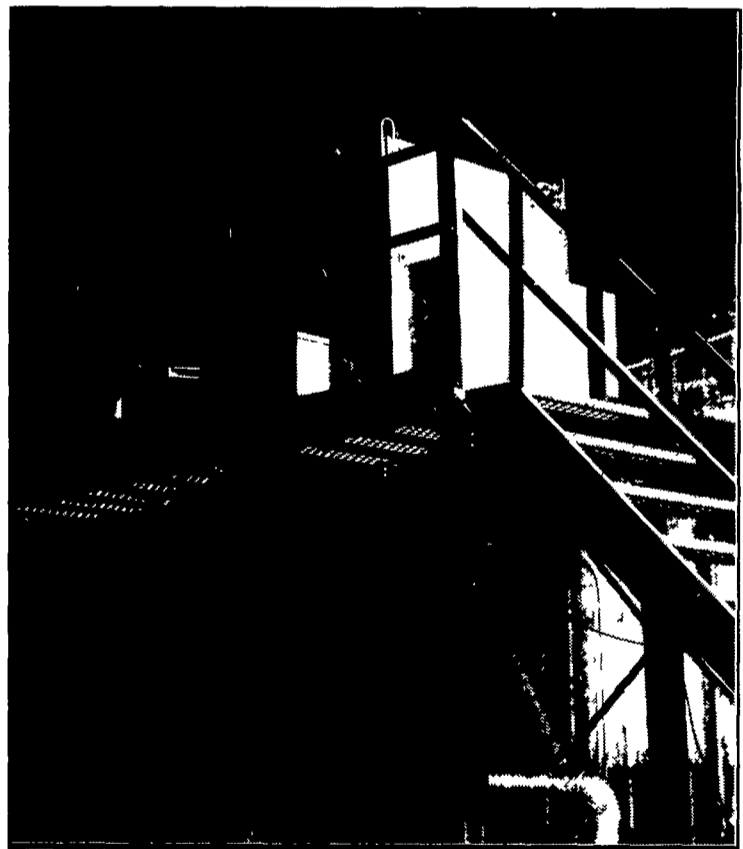

**ON DISPLAY AT OUR
 OPEN HOUSE**

EDAR CREST

EQUIPMENT

717-866-1888

339 King Street
 Myerstown, PA 17607

800-646-6601

