

- 7240 CORN & SOYBEAN PLANTER, Excellent Shape, Used Little.....\$15,000
 - JOHN BLUE SPRAYER, 38' Booms, 1000 Tandem A, Big Pump.....\$2,500
- 301-972-7374**

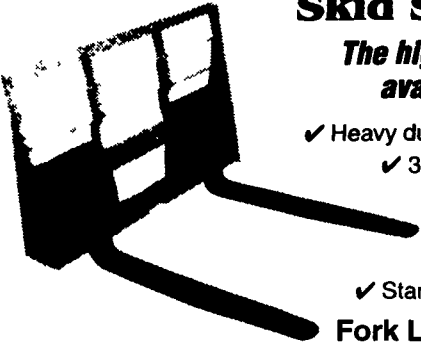

Skid Steer Fork Ass'y

The highest strength assembly available for the money!

- ✓ Heavy duty construction
- ✓ 3,500 pound capacity
- ✓ Safety guard standard
- ✓ Universal mounting to fit new generation skid steers
- ✓ Standard sizes in-stock for fast delivery

Fork Lengths 42"@\$560 48"@\$580

NEW	SKID LOADER BUCKETS		
60" Utility	66" Utility	72" Utility	
\$499	\$528	\$563	

GB Equipment - 717-530-0120

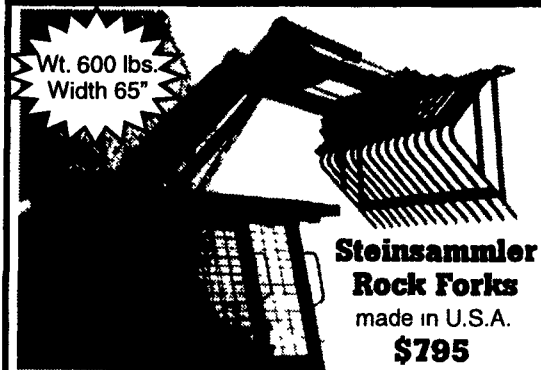

Wt. 600 lbs.
Width 65"

Steinsammler Rock Forks
made in U.S.A.
\$795

Built with 1 1/2" hi-tensile shafting, will fit Case - NH - Bobcat Quick-Tach.

Burkholder Equip.
Shippensburg, Pa.
1-800-456-7516

McGrew Equipment, Inc.

2191 Seven Valleys Rd.
Seven Valleys, PA 17360

Located 6 miles south of Rt. 30 or minutes from I-83

Office (717) 428-0922

Cell (410) 299-3326

Home (410) 239-9399

Fax (717) 428-0831

email MCGREWEQUIPMENT@MSN.COM

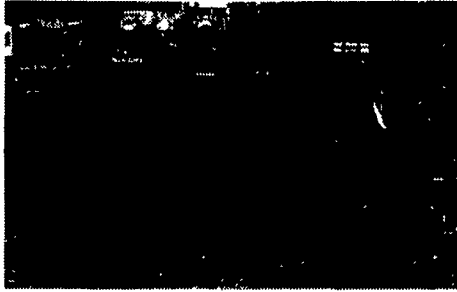

N.I. 5209 discbine, "red" nice!! \$8,600

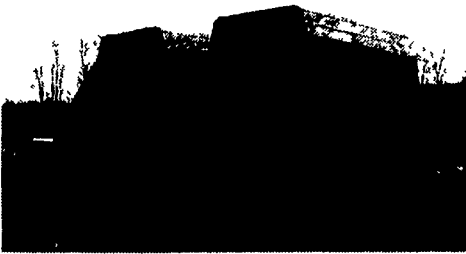

2 JD 714 Silage Wagons w/JD 1275 Tandem Gears \$2300 Ea.

TRACTORS:

- JD 3055 C.A.H. w/Ldr..... Coming In
- IH 1466 C.A.H. Duals, Wghts., Good TA. \$9,200
- AC 6060 2WD 4500 Hrs. w/Ldr..... \$6,500
- MM Super U-302 W.F. 3 Pt. \$4,800
- MF 35 Diesel..... \$3,200
- Ford 3600 Diesel, P.S..... \$5,900
- Cub 184 w/Blade & Chains \$1,600

COLLECTOR TRACTORS:

- JD 520 Ser #5 Wow!! 5th One Built..... \$4,950
- JD 620 Tri. 3 Pt..... \$4,750
- JD 520 w/3 Pt..... \$4,250
- JD 1010 Turf Special, Scarce!!! \$4,000
- JD H Nice Orig Hand Start..... \$3,300
- JD B With Behlen Road Gear, Unique!!..... \$2,400
- Farmall F30 Full Round Spokes..... \$2,500
- IH 100 w/Cult. and Fast Hitch..... \$3,200

CONSTRUCTION

- Kubota KH 35 Mini-Excavator..... \$6,250
- Terramite T5C T.L.B., 1997, 1000 Hrs..... \$8,300

COMPACTS & LAWN & GARDEN

- Simplicity 20 HP Sunstar, 60" Deck P.S.... \$2,000
- Kubota B7200 4x4, 900 Hrs..... \$4,200
- Bolens G-152 Diesel w/Mower..... \$3,250
- JD 140 H-3 w/3 pt..... \$1,500
- JD 140 H-3..... \$975
- Case 444 w/Log Splitter, Mower, Blade & Snow Blow, Nice!!!! \$2,200

EQUIPMENT:

- Flat N.H. 451, Like New, Cut Less Than 20 Acres..... \$3,150
- JD 335 Round Baler, Less Than 1000 Bales Like New..... \$8,000
- Ford NH 474 Haybine, Sharp..... \$5,200
- JD 710 Mo-Co Haybine, Very Little Use Sharp!!..... \$6,750
- Woods 2126 Bush Hog, Hard Tires, Chains, Like New..... \$4,950
- 3 Pt. 7' Disc Mower, Like New..... \$2,200
- Vermeer Twin Fold Rake..... \$3,000
- Hesston 3 Pt. 4 Star Tedder..... \$1,100
- Tye 14' No-Till Drill w/Grass Seed..... \$3,500
- "NEW" KD Ldr. for JD Utility Tractors... \$2,600
- NH 256 Dolly Wheel Rake, New Paint... \$2,400
- Deutz-Allis 4x No Till Planter..... \$1,950
- AC 330 Corn Head, Nice!!! \$850
- JD 4400 Diesel Hydro w/Grain Head \$5,000
- Case IH 1190-9 Haybine, Sharp!..... \$3,500
- Pittsburg 10 ft. Trans, Disc Nice!!! \$1,100
- New Idea 3 Beater PTO Manure Spr... \$1,900
- NH 451 Sickle..... \$1,250
- JD 8 Ft. Lime Drill Nice!! \$700
- Danuser PHD Heavy Duty..... \$900
- MF 2x Planter, 3 pt, flex Hitch, Nice!!... \$675
- JD 1x3 Pt Planter..... \$225
- IH 310, 3 Pt 1x Plow Like New... \$475
- 2000 26 Ft. Enclosed Racing Trailer, Inside Finished, Nice..... \$7,000
- New King Kutter 6 Ft. Finish Mower \$1,025
- Several New & Used 3 Pt. Equipment, Trailers, Etc.

Kingsdale Semi-Annual Sale - Sat, May 18

- JD 4020 Diesel Power Shift High-Crop Good Tag "Fully Restored"
- JD BO Lindeman Crawler "Completely Rebuilt" To Be!!! Sold Absolute!!!

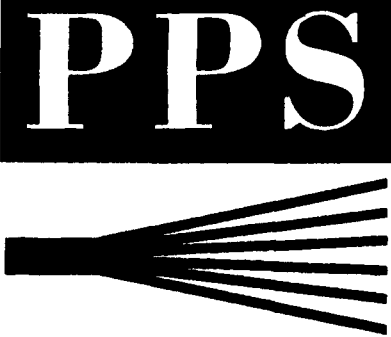

PROGRESSIVE PRESSURE SYSTEMS

1248 EAST NEWPORT ROAD
LITITZ, PA 17543

Pressure Washers • Water Recyclers
SALES & SERVICE

717-626-5511 • Fax 717-626-5098

**COME VISIT US DURING
OUR CUSTOMER
APPRECIATION DAYS**

APRIL 15-19
7am to 5pm

**Door Prizes and
Refreshments
the Whole Week**

Web: www.progressivepressure.com
Email: info@progressivepressure.com

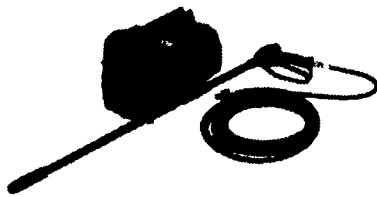

**10% CASH
Discounts**

Given on Farm Plan, Discover,
VISA, MasterCard, and
American Express Purchases
of Parts & Accessories

**Any
Parts &
Accessory
order over
\$500⁰⁰**

Paid
with check or
cash an extra 5%
will be given

Introducing the NEW 2002 Models of  Equipment

Get a FREE Hands On Demo

**Great
Prices on
Equipment**

**DOOR
PRIZE**

**The Chore
Master**

by MI-T-M
CM-1250-A

Portable Cold Water
Pressure Washer



- Electric Powered
- Oil Fired
- Belt Driven
- Up to 3000 Psi @5 GPM

FREE SNACKS

- Self Contained
- Gas Powered
- Oil Fired
- Heavy Duty Belt Driven
- Up To 4000 Psi @5 GPM

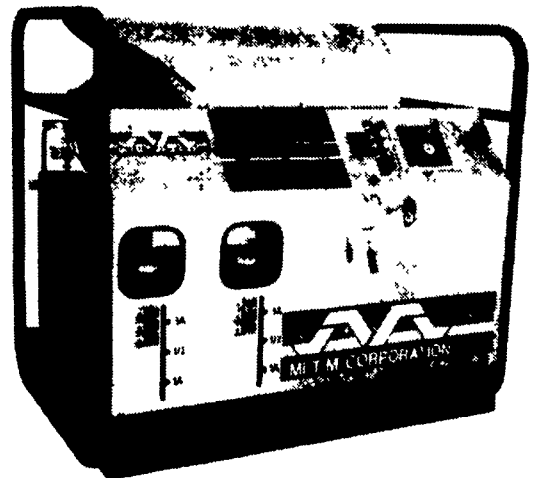

Introducing
**John
BEAN
SPRAYERS**