

Penn State To Provide IPM Information To Retail Shoppers

UNIVERSITY PARK (Centre Co.) — Home gardeners in two Pennsylvania counties who want to minimize their use of pesticides and fertilizers soon will be able to get tips and advice while shopping at their local garden centers and chain stores.

Beginning this fall, Penn State's College of Agricultural Sciences, in cooperation with the Pennsylvania IPM Program, will provide free information on integrated pest management (IPM) and nutrient management to retail shoppers in Franklin and York counties. "Our long-term goal is to expand the project to other areas of the state and work with counties in Maryland as well," said Steven Bogash, Penn State Cooperative Extension horticulture agent in Franklin County.

IPM aims to control pests — such as insects, diseases, weeds and animals — by combining physical, biological, and chemical tactics that are safe, profitable and environmentally compatible.

"In the case of home plantings, proper variety selection and good site preparation can help avoid many future pest problems," Bogash said. "Consumers need this information when they are planning their garden and purchasing plants."

Under a grant from the U.S. Environmental Protection Agency and the Pennsylvania Department of Agriculture, Bogash and Thomas Becker, Penn State Cooperative Extension horticulture agent in York

County, will assess the needs of garden centers in York and Franklin counties and provide the centers with information about proper IPM practices that can be shared with consumers. A full-time educator will be hired to visit individual stores and disseminate educational materials.

"After the needs assessment this summer, we'll begin supplying information for the fall mum season, and then fact sheets on Christmas trees and house plants for the winter," Bogash said. Consumers also will receive information on classes offered by Penn State Cooperative Extension.

Project personnel also will work with the Southeast IPM Research Group — an organization of university and "green"

industry collaborators in Pennsylvania and Delaware (<http://sepaipm.cas.psu.edu>) — to develop fact sheets on gardening topics such as choosing plants that are most resistant to diseases and plants that require less pesticide.

"In the past, we've relied on people coming to us for information, but we feel that most people only have time to shop at retail outlets and tend to their garden," said Bogash. "If they do need advice, they typically ask someone who is trying to sell them something. Through contact at the retail level, this project will give consumers useful and unbiased information and raise awareness of the IPM work being done by Penn State and other land-grant universi-

ties." For more information, contact Steve Bogash (717-263-9226, smb13@psu.edu) or Tom Becker (717-840-7408, tbecker@psu.edu).

The Pennsylvania IPM Program is a collaboration between Penn State and the Pennsylvania Department of Agriculture aimed at promoting IPM in both agricultural and nonagricultural situations. For more information, call (814) 865-2839 or visit the program's Website at <http://paipm.cas.psu.edu>.



See All The STEINER EQUIPMENT Working At AG PROGRESS DAYS Between East 2nd & 3rd Streets

STEINER TURF EQUIPMENT

Does your equipment allow you to change each one of these attachments without tools and in a minute?

You Could With A



4x4 And 2x4

See All The STEINER EQUIPMENT Working At AG PROGRESS DAYS Between East 2nd & 3rd Streets

"Quick Change Artist"

Gas or Diesel, Fully Hydrostatic Power Units Available in 16, 20, 21, 25 & 28 HP. Here Are Some Of The Interchangeable 40+ "Front Mounted" Attachments

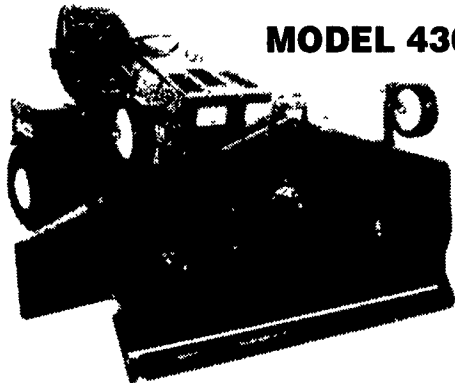

MODEL 430

FRONT MOUNTED DECKS
Flip Up For Maint.
4'-5'-6'

Attention:
Municipalities, Schools, Counties, Parks, Etc....
Steiner Turf Equipment Is On PA STATE CONTRACT.

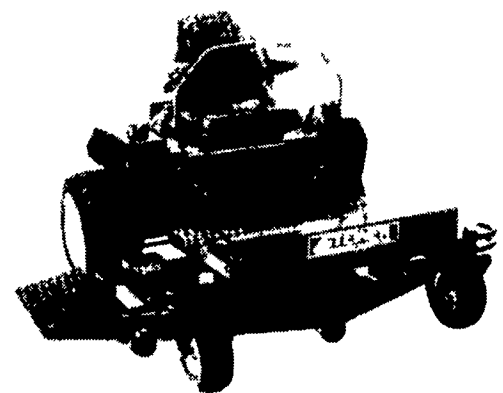

MODEL ZTM 325

ZERO TURN MOWERS
52" & 61"
20 to 27 HP

MODEL 525 4X4 WITH 48" SNOW BLOWER
Hydraulic Rotating Chute

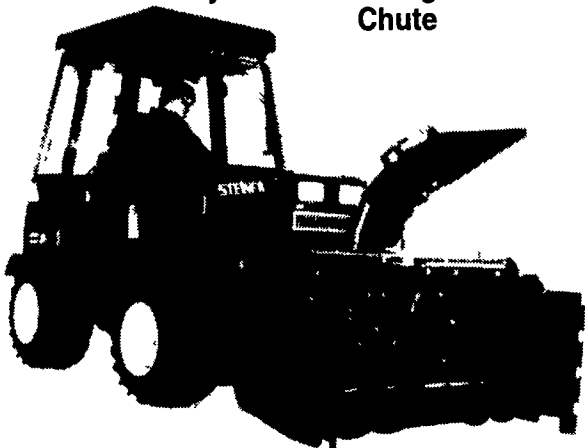

54" ROTARY BROOM

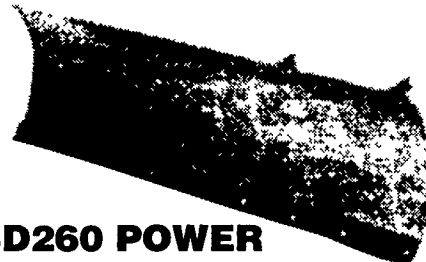

BD260 POWER ANGLE BLADE

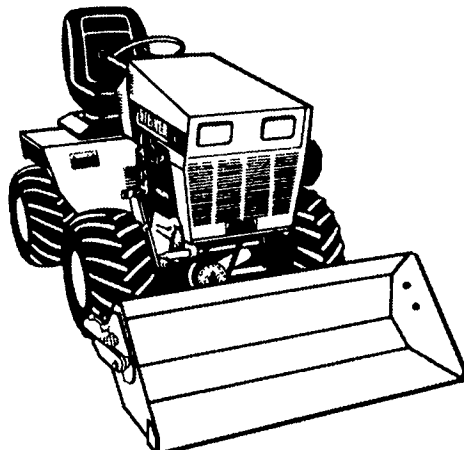

MODEL 410 w/Slip Scoop

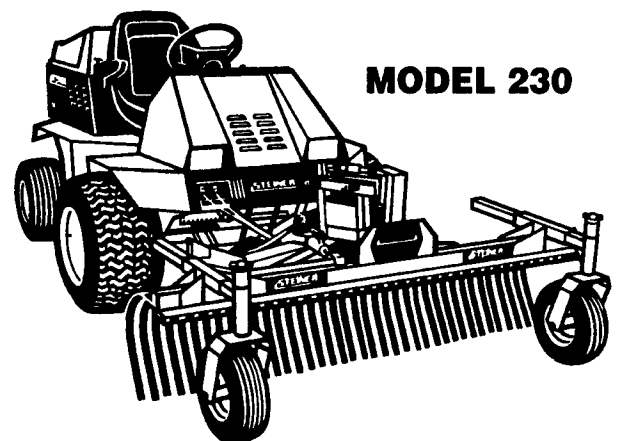

MODEL 230

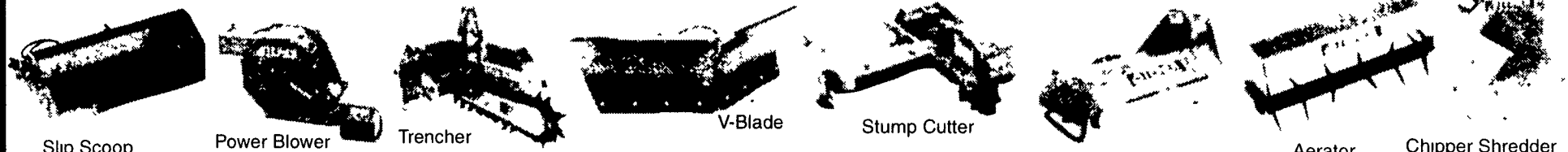

Authorized Dealers

ROY'S STEINER SALES & SERVICE

151 Soursley Road, Lenhartsville, PA 19534
610-756-6150
web site: www.thecyberlinks.com/steiner

J & R SHEDS & EQUIPMENT INC.

3025 Churchville Road, Churchville, MD 21028
410-399-4102
3639 Grier Nursery Road, Street, MD 21154
410-452-8521

HENRY H. HARTMAN

Steiner Sales & Service
2300 Black Rock Road, Hanover, PA 17331
717-637-3741 - 1-877-4STEINER
www.limousin1.com/pages/hartman