

1 FARM EQUIPMENT

Jonestown Ag Repair Shop
Skid Loader Repairs & Rentals
 Our Specialty
 Affordable prices on transmission and hydraulic repairs.
 Firestone and Galaxy skid loader tires sold here. Call For Prices
Painting & Sandblasting
 170 Old Rt. 22, Jonestown, PA 17038
 Darwin Weaver
 717-865-9427 717-865-9096 Fax

FARM TRACTORS FOR SALE

- JD 1830 2WD same as 2440... \$7,500
- JD 2555 2WD..... \$13,200
- JD 5410 2WD, Like New... \$19,800
- JD 2355 2WD..... \$13,200
- JD 6200 2WD Syncro+Trans..... \$14,200
- JD 6200 2WD Syncro+ w/Cab. \$19,100
- JD 5510 2WD 400+ hrs. \$20,500
- JD 7400 4WD Cab, PQ Trans. ... \$33,200

(570) 966-1961

USED TRACTOR PARTS, also rebuilt clutches and forques. We ship UPS. Hill-T Farm Inc., 4295 Richmond Palestine Rd, New Madison, OH 45346. 937-548-0718.

Like brand new Tanco wrapper 550S, 30" trailer, cut & start. 570-222-9020.

FORKLIFTS: Direct wholesale liquidation. Must sell. Many makes. Call J.R. 215-937-1146

1987 Kubota tractor, L2550, dsl, 4WD, front end ldr, mower deck, post hole digger, York rake-rear blade, very clean, \$11,200. 215-598-8240.

94 JD 6675 skid steer, same as NH LX565, runs good, looks good, approx. 1500 hrs, \$10,750. 717/336-7375.

Latest model M2 you can buy. Has M3 electronics, and features. Low hours, Priced \$3,000 under normal. Only \$12,500. This is best value on M2 on East Coast. Zeisloff Eq. 800-919-3322.

Buy - Sell - Repair Over 30 Tractors In Stock
 (2) Case 930 6 spd, w/pully 1-rub., 1-steel..... CALL
 Case 1030 WF, 3 pt, 1000 PTO, nice \$4,700
 Farmall H, nice straight, good runner \$1,100
 IH 1466 cab, dual PTO, no 3 pt, nice..... \$7,100
 MF 1155 w/cab, recent engine work, nice \$6,600
 IH 460 gas, w/loader, runs nice..... \$3,400
PARTING OUT: Case 930, 830, 900, 500,300, LA, L, DC, SC, S, VAC, RC, IH 656 Hydro, 660, 560, 650, 19, W9, WD9, M, H, F20, MH 101 Jr., JD B, Oliver 70, Super 77 diesel, MM UTU
 Some used tires. New & Used Parts & Supplies.
King's Tractor 717-529-4066
 1426 Noble Road Kirkwood, PA 17536 8 am to 8:30 am

THE FOAM FORCE Free Estimates
 Fully Insured
 Uses For Spray Foam Insulation Are:
 Refrigeration, Tanks, Metal Bldgs., Cow Barns, Mushroom Houses, New Homes, Etc. R Value 6.7 Per Inch
PAUL H. COLLINS
 Urethane Foam Systems
 369 Eden Road, Quarryville, Pa. 17566
Phone: 717-786-0757
Fax: 717-786-7403
 Clip & Save This Ad

1996 JD 8400 MFWD, Duals, Front Weights, 2800 Hrs., Real Clean 2 Year Warranty \$72,900
 717/529-2512 (No Sunday Calls)

1990 MF 3120, 4WD, 3,250 Hrs., New Clutch & Pressure Plate \$29,500
 (717) 627-6473

SKID LOADER BUCKETS on hand

 Universal mount. Also to fit Case, NH, or Custom made for you. Any size
Lancaster Silo Co., Inc.
 2008 Horseshoe Rd, Lancaster, Pa
(717) 299-3721

LESTER HORNING
 585 Indiantown Rd • Ephrata, PA 17522
717-738-1677

 JD 2750 Diesel, Hi-Lo. only 3,700 Hrs. 1 Owner. \$14,500

USED EQUIPMENT
 NI Manure Spreader
 NH 795 Spreader
 NH 800 Spreader
 Deutz 4.70 w/Cab
 MF 1230 4WD Hydro
 NI/WF 5100 6R Planter
 NI/WF 6100 6R Planter
 NI 325 Picker, 2R 30"
 NH 351 Grinder
 NH TR96 Combine w/Heads, \$38,000
 JD 348 Baler
 NH 855 w/Bale Command
 NH 660 Auto Wrap
 NH 1496 Haybine
 NH 1495 Haybine
 1998 NH 900 Chopper
 NI/WF 5100S Splitter
 (3) Rotary Hay Rakes
 Round Bale Slicer
 Case IH Hydro Disc Mower Conditioner
"Give Us A Try Before You Buy"
J. DAVID MULLINIX & SONS, INC.
 (410) 489-4363 - FAX (410) 489-7634
 14420 Howard Rd., Dayton, MD 21036

FILTERS

 Hydraulic Oil Filter
 Fuel Filter
 Air Filter Element
 Oil Filter

 Hy-Gard 30 Gal. TY6238

 Pisto-grip Grease Gun TY15381 \$15⁹⁰

 Chain Lubricant TY22087 Case \$43⁰⁰
JOHN DEERE
 WE SHIP UPS DAILY
10% OFF ALL Fleetguard Oil Filter (reg.) PMLF3316
12% OFF SELECTED FILTERS*
 *Valid Thru January
 30 Gal. TY6238 Hy-Gard..... \$138⁰⁰
 TY22010 15W40..... 160⁰⁰
 55 Gal. AR69445 Hy-Gard..... \$235⁰⁰
 TY6391 15W40..... \$242⁰⁰

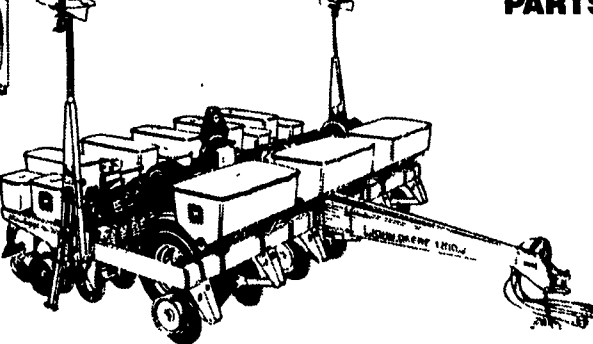

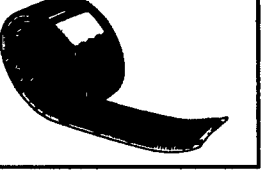

PLANTING & SEEDING PARTS

Tru-Vee™ Planter Opener AA37474
 Planter Finger AA31261 \$24⁶³
 Planter Seed Brush AA35660 \$3⁶⁵
 Seed Belt A65266 \$5⁹⁹
Featured Price \$19⁹⁹ ea.
 Many Other Items On Sale

HAY EQUIPMENT
 \$5²⁵/ft.
 Cut to Length

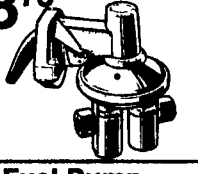
 JD Bulk Baler Belting AE54370

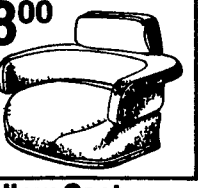
TILLAGE PARTS
 Twisted Shovel
 Plow Moldboard Shin
 Plow Share 4-bolt



Solid Disk Blade
SAVE 15%
 18" B31315..... \$12⁰⁰
 20" B31318 7 ga.... \$16⁰⁰
 20" A49254 9 ga.... \$20⁰⁰
 22" A35487 1/4"..... \$29⁷⁵
SAVINGS OF 20% ON DISK BLADES
 *Prices In Effect Thru January 31, 2000

Reman Engines Call For Prices

Fuel Pump RE42211 \$38⁷⁵

Shop Towels TY16353 \$8⁹⁹

Yellow Seat Cushion Kit - Ag TY9326 \$128⁰⁰

Amber Strobe Light PMST550M \$85⁰⁰

Starting Fluid RE33636 \$1⁴³

Landis Bros., Inc.
 Route 283 & Rt. 772 Manheim/Mt. Joy Road, Lancaster, PA
 30 Evergreen Rd. Lebanon, PA 17042
 Mon-Fri 7:00-5:30 Sat 7:00-12:00
 Sun-Fri 7:30-5:00 Sat 7:30-12:00
 1-800-524-3276 717-653-2340 1-800-327-6524 717-228-2650