

### HOW BIG A COOLER DO I REALLY NEED?

Depends on a lot of things. But one thing's certain Mueller makes the milk cooler that's right for your operation. And it's built to last. So it'll have high resale value the day you need a bigger cooler. For help deciding how big a milk cooler you need, contact your local Mueller dealer.

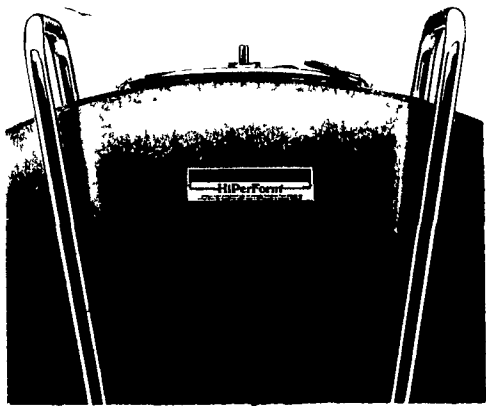

**Martin's Refrigeration, Inc.**

Phone (717) 352-2783 1122 Woodstock Rd  
Sales & Service Fayetteville, PA 17522

MUELLER THE MILK COOLING EXPERTS

FREE Dairy Farm Equipment, W. Brandywine, Chester Co. Silo Stanchions & more. You Dismantle & Haul. 610/469-1119 8-5.

Universal pipeline milking system w/automatic washer, 1 1/2" glass line for 40 cows, \$100 cash; 80 gal. electric water heater, \$25; feed cart \$35. 717/564-2277.

**WANTED:**  
Good Used Milk Tanks - Any Size  
No Ice Banks or Girton  
1-800-448-4697

### BARN CLEANER REPAIRS

NOW IS THE TIME... SAVE MONEY & GRIEF

Double wide wear shoe combined with thicker paddle provides up to 90% more contact area to greatly increase wear life.

**SUPER HOOK**  
Heaviest chain in the industry

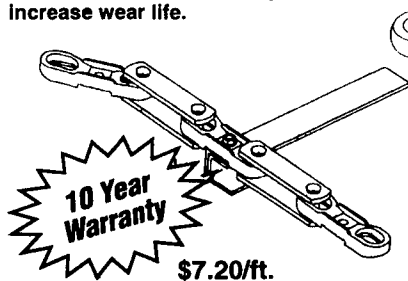

\$7.20/ft.

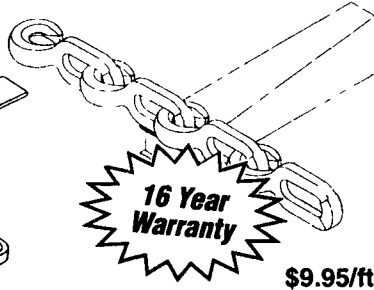

\$9.95/ft.

**J&D Manufacturing**

Hess Equipment Sales & Service

RR3, Box 160, Mifflinburg, PA 17844  
717-966-1998

**PAUL B Zimmerman INC**

### LOOP STALLS

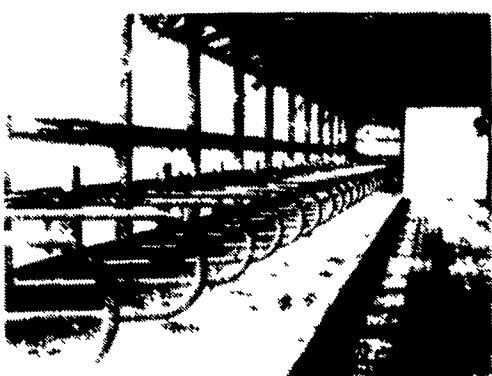

Finished with Baked-on top Grade Polyester TGIC Powder Coated after Fabrication. Greater Cow comfort in shorter stall beds and provides more side Headroom in the Lunge Process

**Plus:** Comfort Stalls, Headgates, Headlocks, Gates, Fencing, Hay Feeders, Bale Movers, Water Bowls, and more  
**Accessories in Stock too**

Sales & Service

**ROVENDALE AG & BARN EQUIP.**

WATSONTOWN, PA 17777

717-538-9564 OR 717-742-4226

Exit 31 I-80 to I-180 Watsonstown Exit  
Hours: Mon-Fri 8 to 5 Sat 8 to 12



### ATTENTION DAIRY FARMERS

We Need Good Used Tanks  
600 - 6,000 Gal. - Call Us

- 150 Gal Zero Self-Contained (nice)
- 150 Gal Mueller RH
- 155 Gal **SOLD PA**
- 180 Gal Milkkeeper
- 200 Gal **SOLD SA**
- 250 Gal Mueller M
- 300 Gal Sunset
- 300 Gal Mueller M
- 400 Gal Girton D4
- 400 Gal Milkkeeper (Self Contained)
- 500 Gal DariKool
- 500 Gal Mueller O
- 500 Gal Sunset
- 500 Gal **M/SOLD OH**
- 500 Gal Majonmer
- 500 Gal Girton
- 500 Gal **SOLD PA**
- (3) 600 Gal Girton
- 600 Gal Mueller M
- 600 Gal Mueller OH
- 600 Gal Sunset
- 600 Gal Storage
- 625 Gal Girton D5
- 700 Gal Mueller "M"
- 700 Gal Mueller O
- 735 Gal Sunset
- 800 Gal Mueller M
- 800 Gal Girton D-4
- 800 Gal Girton D5
- 800 Gal Mueller OH
- 1000 Gal DariKool Late Model
- 1000 Gal **SOLD CN**
- 1000 Gal Mueller M
- 1000 Gal Mueller OH (3)
- 1000 Gal Mueller OE (Late Model Nice)
- 1000 Gal Sunset (Rd)
- 1000 Gal Sunset (Flat)
- 1000 Gal **SOLD PA**
- 1000 Gal Storage
- 1000 Gal Girton D5
- 1250 Gal Storage
- 1250 Gal Mueller M
- 1250 Gal Mueller OH
- 1250 Gal Girton D5
- 1250 Gal Surge
- 1250 Gal Van Vetter
- 1250 Gal DeLaval
- 1500 Gal **SOLD PA**
- 1500 Gal DariKool
- 1500 Gal Mueller O
- 1500 Gal Mueller M
- 1500 Gal Mueller OH
- 1500 Gal **SOLD PA**
- 1500 Gal Girton D2
- 1500 Gal Girton D5
- 2000 Gal Mueller O
- 2000 Gal Mueller OH (2)
- 2000 Gal Mueller OH (Late Model)
- 2000 Gal DariKool (late model)
- 2000 Gal Surge
- 2000 Gal Mueller M
- 2000 Gal Storage
- 2000 Gal Zero
- 2500 Gal Girton D5
- 2500 Gal Storage
- 2700 Gal Storage
- 3000 Gal Globe (DariKool)
- 3000 **(SOLD OH)**
- 4000 Gal Storage

**HEAT EXCHANGERS**

• Thermo Stor 80 • Thermo Stor 100

• Mueller Fre Heater 105 Gal.

• Thermo Stor III, 120 Gal. • Mueller Fre Heater 50 Gal.

• 300-6000 Gal. Storage Tanks

Installation, Sales And Service

**RAY SHENK**

505 E. Woods Drive  
Sales 717-626-1151

Lutz, PA 17543  
24 Hr. Service

### THE LEGEND LIVES



- Durable And Reliable - Engine Life Routinely Exceeds 20,000 Hrs
- Lower Fuel Consumption
- Exceeds All Pending Exhaust Emission Requirements
- Genuine Bosch Injection Equip.

Air Cooled And Water Cooled  
Engines In All Horse Power Ranges  
For A True Heavy Duty Diesel Without The  
Heavy Duty Price Tag, Call Today  
Used Deutz power units available

**RUFUS BRUBAKER REFRIGERATION & POWER**

76 Pumping Station Rd Quarryville, Pa 17566

717-786-1617

24 Hr. Emergency Service Available

### BARN CLEANER REPAIRS

NOW IS THE TIME... SAVE MONEY & GRIEF

Double wide wear shoe combined with thicker paddle provides up to 90% more contact area to greatly increase wear life

**SUPER HOOK**  
Heaviest chain in the industry

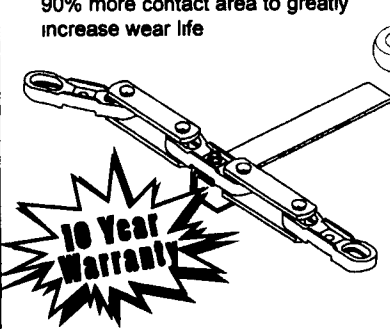

10 Year Warranty

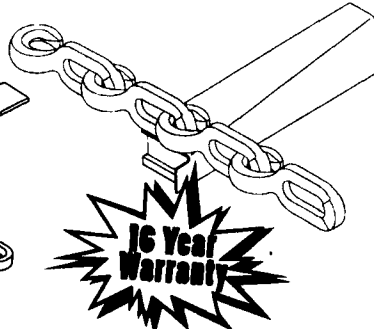

16 Year Warranty

REPLACEMENT CORNER WHEELS & SPROCKETS

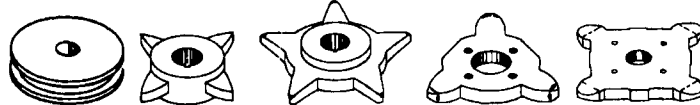

**REPLACEMENT DRIVE HEADS FOR BERG® & PATZ®,  
REPLACEMENT CHUTES TOO!**

Parts for Badger®, Berg®, Patz®, Clay®, Hedlund®, & Jamesway®

**J&D Manufacturing**

Eau Claire, Wisconsin 54701

e-mail: jdmfg@jdmfg.com

Call For Your  
Nearest Dealer  
And Save

1-800-998-2398

LOCAL WAREHOUSE #310-223-5151 8 AM TO 5 PM M-F  
CALL FOR THE DEALER NEAREST YOU or CONTACT:

KRIS KNUDSEN-AREA MANAGER  
717-653-0385 Fax 717-653-0243

### BULK MILK TANKS

Walk-in coolers and small tanks

**Musser's Refrigeration**

127 Leacock Rd, Gordonville, PA 17529  
Corner of Peters Rd. & Leacock Rd.  
3 mi. South of New Holland

(717) 355-0572

if no answer (717) 354-6274

Vernon Musser (proprietor)

maximum efficiency

Piston  
Pumps

YOUR  
ALL-IN-ONE  
FARMstead  
EQUIPMENT  
SOURCE

**J-STAR**

EFFICIENCY AT ITS BEST!

Now get the best of Van Dale® and Neweth® in J-STAR's heavy duty piston pump. A proven design, its hollow cast iron piston in a formed steel chamber is more dependable and efficient than other methods of moving manure to storage and requires little maintenance. J-STAR's piston pumps also offer:

- Fast manure handling up to 50 cu ft per minute
- Easy, economical and versatile installation
- Three year warranty
- Re-New kits to upgrade your current system

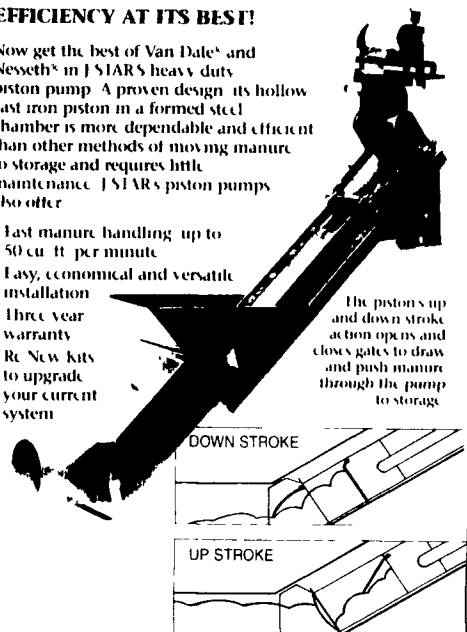

The piston's up and down stroke action opens and closes gates to draw and push manure through the pump to storage

For a trouble free, low maintenance system that offers you maximum pumping power, look no further than the one name that says it all - J-STAR

### LAPP'S BARN EQUIPMENT, INC.

5935 OLD PHILADELPHIA PIKE

GAP, PA 17527

PHONE: 717-442-8134

717-768-8301

WE SERVICE WHAT WE SELL  
Radio Dispatched Trucks



### LIVESTOCK EQUIPMENT

Purebred Angus/Bulls All sires Ease calving low birth weight if you are looking settle cows and heifer these are the ones. 717-768-3651

### KENCOVE FARM FENCE

344 Kendall Road, Blairsville, PA 15717-8707

FREE GUIDE

"TENSILE FENCE"

1-800-245-6902

724-459-8991

Crimp Tool - 4 Slot

\$49.<sup>50</sup> (TRC)

12-1/2 Gauge Crimp Sleeve \$9/Per Hundred



### PRO FENCE

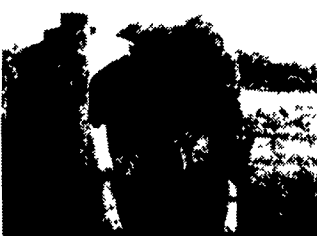

Call for prices on high tensile fencing

140 High Rd Shippensburg, PA 17257  
(717) 530-0128 1-800-433-6236

"Good Fence / Good Neighbors"

### Beaver Fence Systems

Rail Fence HORSE HIGH BULL STRONG Board Fence

"Specializing in High Tensile Wire Installation"

HORSE FENCES • CATTLE & SHEEP FENCES  
DEER CONTROL FENCES • TRELLISES  
FREE ESTIMATES

145 Jacks Mountain Rd  
McVeytown, PA 17051

(717) 899-7617  
S.A. Yoder