

NORTHEAST'S AGRICULTURE SHOW PLACE



"The Farmer's Choice For Over 41 Years"

THE MOST READ FARM PUBLICATION IN THE RICHEST AGRICULTURAL AREA OF THE MID-ATLANTIC STATES WITH OVER 49,000 PAID SUBSCRIBERS THROUGHOUT PENNSYLVANIA AND NEIGHBORING STATES.



Reader Interest Is At An All-Time High!

Reader Spends Average of 122 Minutes with Each Week's Issue!

1996 STARCH PROFILE OF FARM MARKETS OF 42 NATIONWIDE PUBLICATIONS

Actions Taken After Reading *Lancaster Farming* By Principal Operators and Decision Makers

- # 1 when asked if readers cut out the advertisement!
- # 1 when asked if readers discussed the advertisement!
- # 1 when asked if readers visited the dealer!
- # 2 when asked if readers sent for information!
- # 1 & # 2 Readers likeableness and usefulness ratings!

THE FARM NEWS FARMERS WANT!

- COMPLETE DHIA NEWS
- FARM BUSINESS NEWS
- 4-H AND FFA NEWS
- MARKET REPORTS Hog, Dairy, Poultry, Horses, Hay
- FARM CALENDAR
- CLASSIFIED ADS SECTION
- FARM WOMEN'S NEWS
- PUBLIC AUCTION REGISTER

1 East Main Street, P.O. Box 609, Ephrata, PA 17522
717-394-3047 or 717-626-1164 Fax 717-733-6058

SEE US AT EMPIRE FARM DAYS AUGUST 11, 12, 13 - BOOTH #469

MAHONING OUTDOOR FURNACES

WORKS FOR ALL EXISTING SYSTEMS 3 YEAR WARRANTY SAFER! LESS CHANCE OF HOME FIRE. NO CARBON MONOXIDE FROM FURNACE IN HOME. EFFICIENCY RATING 83% TO 85% CUT EMISSIONS BY 90%

"THE NATURAL WAY TO HEAT"

COAL OR WOOD THIS BOILER HAS GRATES

HEAT TRANSFER BY UNDERGROUND PIPES 25' to 100'

HEAT YOUR HOME, FARM OR COMMERCIAL BUILDING

NO DUST OR DIRT BEYOND THE POINT

HEAT YOUR POOL

STANDARD MODELS WOOD - COAL

MULTI-FUEL MODELS WOOD - COAL - OIL - GAS WASTE OIL

CHARGE ONLY ONCE 8-12 HOURS ONCE WEEK IN SUMMER (FOR HOT WATER)

NOTICE: CARRY FUEL NO FURTHER THAN HERE!

Mahoning Outdoor Furnaces

1-800-692-5200

DEALERSHIPS AVAILABLE IN SOME AREAS!

CHOP-RITE TWO, INC.

Quality American Workmanship!

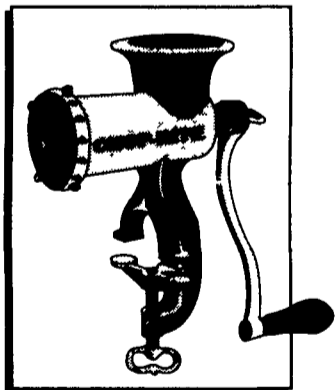

#5 CLAMP TYPE CHOPPER
#10 CLAMP TYPE CHOPPER

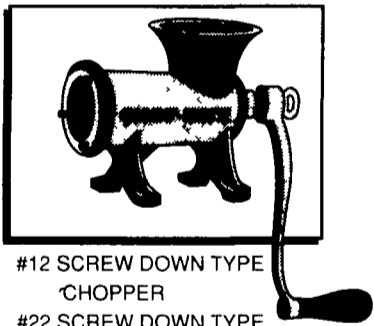

#12 SCREW DOWN TYPE CHOPPER
#22 SCREW DOWN TYPE CHOPPER
#32 SCREW DOWN TYPE CHOPPER

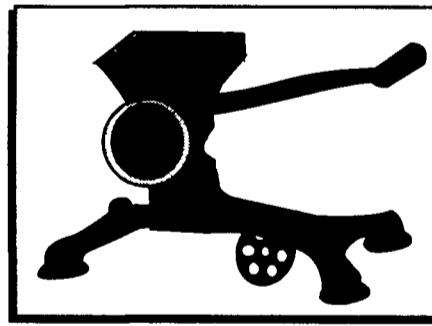

#1 CLAMPLESS TYPE CHOPPER

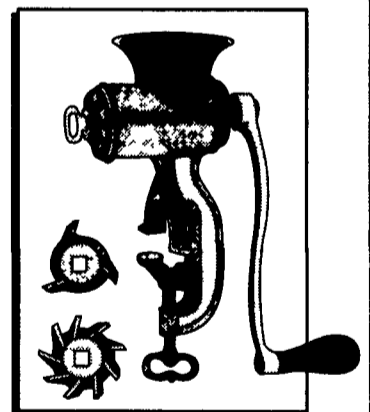

#3 FOOD CHOPPER

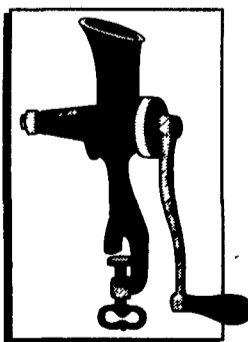

#27 HEALTH FOUNTAIN JUICER

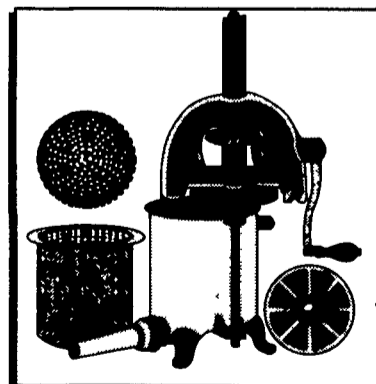

SAUSAGE STUFFER, LARD & FRUIT PRESS

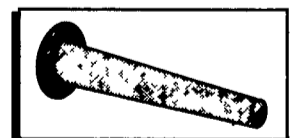

STUFFER HORN AVAILABLE IN VARIOUS SIZES

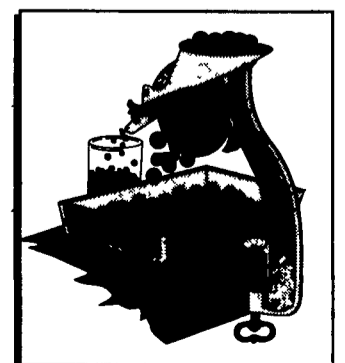

#16T CHERRY STONER

* Plates available in 3/16" (standard), 1/8", 1/4", 3/8", 1/2", 3/4" and 1"

* V-Belt Pullies available for #10, #12, #22 and #32 choppers.

FOR MORE INFORMATION PLEASE CALL OR WRITE :

CHOP-RITE TWO, INC.

531 OLD SKIPPACK ROAD
HARYLESVILLE, PA 19438
1-800-683-5858
FAX (215) 256-4363
www.chop-rite.com



❖ Made in the U.S.A.

❖ Easy to Clean

❖ Made from Cast Iron

❖ Quality Workmanship