

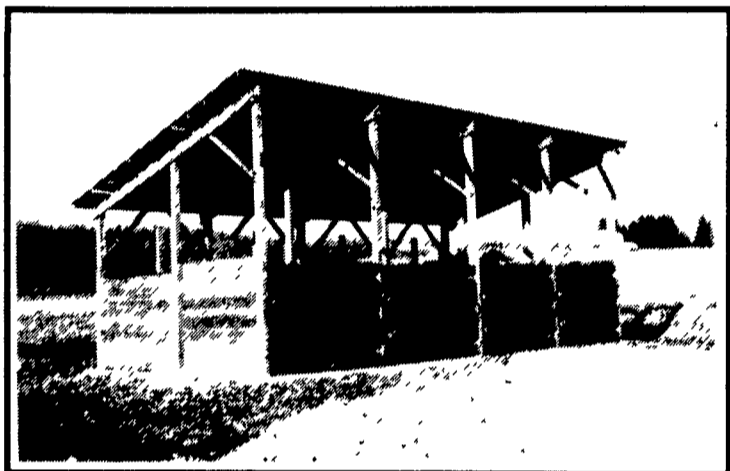

# Thanks and Congratulations to **JEFF & SUE WERNER** Jonestown, PA

**21,800 Tom Turkey Facility  
2 - 50' x 845' Buildings**



**Composter Building**



**TURKEY PAN FEEDING SYSTEMS**

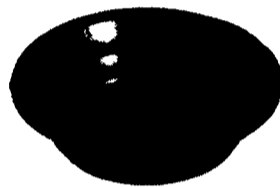
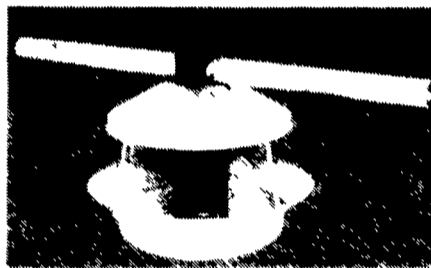

**SIMPLY THE LEADER**  
Cumberland continues being the leader in the manufacturing of poultry equipment by introducing a turkey feeding system for every application. Cumberland's Turkey Feeders have revolutionary features which make them both profitable and easy to maintain for the end customer. Cumberland Feeders deliver feed economically, efficiently, and dependably with savings for the grower. The Cumberland Turkey Pan Feeding System offers a poult turkey pan for young turkeys and two models of adult turkey pans, designed to withstand the rugged treatment of adult turkeys through grow out.

**NEW PLASTIC PAN**  
Easier to clean non-corrosive lighter Cumberland's plastic pan for both STF and RTF Adult Pan Feeders features improved structural engineering with stronger support gussets, a more durable and effective "hanger" for cleaning and a unique set of two feed-saving "catch walls" that significantly reduce raking and billout.



**FEED BINS**

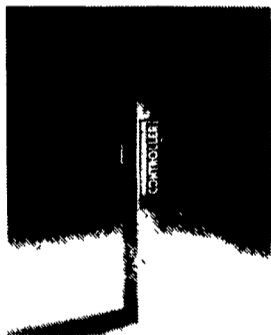

**Screw Drive Curtain Controller**

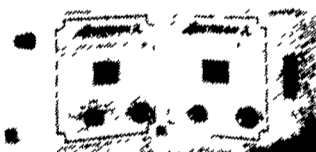

**NVI Controller**  
Precisely adjustable in all ways. Lets you adjust both the run time and the pause time. It even lets you choose a different rate for opening and closing. Adjustable dead band and heater interlock make it the most accurate digital control on the market for ventilation... and it's available for all Curtain Controllers.



**PURA-FIRE HEATER**  
Choose From 2 Models

- C80M - variable output (40,000 or 80,000 BTUH)
- C225 - 225,000 BTUH unit. Each is LP or natural gas compatible and can be mounted inside or outside

your confinement house. Unique "bent flame" design increases flame's surface area and heat chamber efficiency. More warm air is drawn across the fan and blown out side vent.



**FANS**

Twistlink belt on Belt Drive for Ease of Adjustment to Keep at Top Performance.



**Shenandoah**

**BROODERS**



**Big "Z" Drinker with Disc**

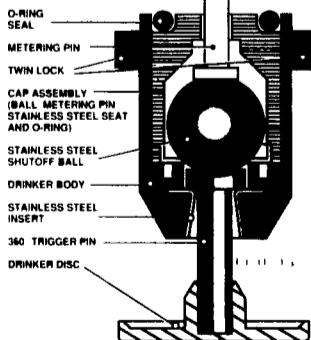

- Larger in size than any other nipple-type drinker on the market
- All stainless steel parts are of the same type series
- Larger diameter stainless steel ball
- Larger diameter stainless steel trigger pin
- Special design stainless steel seat
- Large diameter disc with rim
- Unique in design... the seat isn't part of the drinker body
- The seat, ball, metering pin and o-ring are encapsulated in the cap as a unit
- Positive twin lock hookup between saddle and drinker guard against failures



**BROILER DRINKERS**

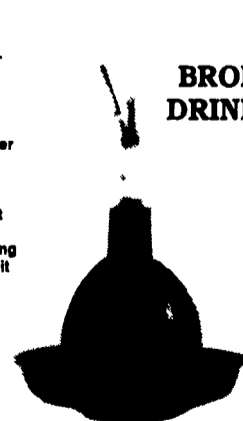

**TURKEY DRINKERS**

Full Line Of Parts In Stock For Your Poultry And Hog Needs

Hours: M-F 7:00-5:00; Sat. 7:30-11:30

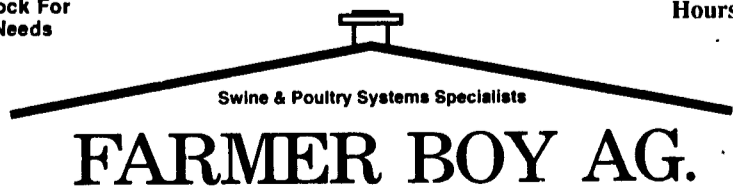

410 E LINCOLN AVE (RT 422) MYERSTOWN PA 17067

PH. 717-866-7565  
1-800-845-3374

WE SHIP UPS

Check Our Warehouse Prices



**For New & Latest Ideas In Turkey Building & Equipment**

**Call Shane Weller For More Information**

- ★ Excellent Contracts Available
- ★ Remodeling Existing Facilities