

2 LOCATIONS TO SERVE YOU

1305 Manheim Pike
Lancaster
800-524-3276
717-291-1046

30 Evergreen Rd.
Lebanon
800-327-6524
717-228-2650

Mon-Thurs 7-5:30 Fri 7-8PM Sat 7-3PM Mon-Fri 7:30-5, Sat 7:30-noon

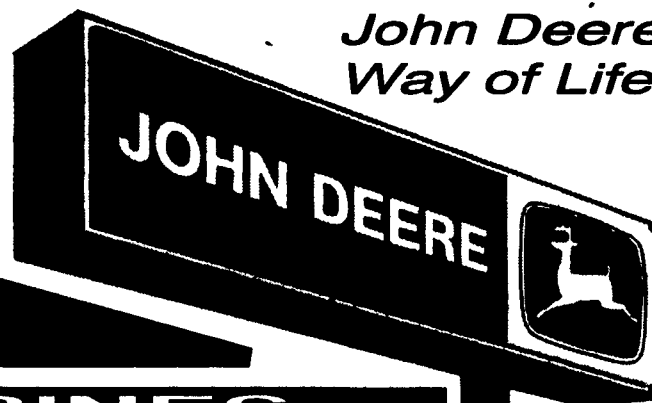

John Deere... A
Way of Life™



TILLAGE
EQUIPMENT



LANDSCAPE
POWER RAKE

USED COMBINES

Just Announced

0% INTEREST
TILL
SEPT. 1995

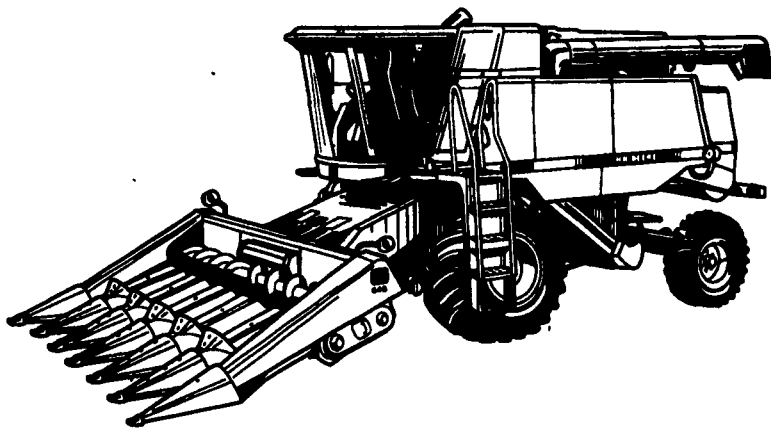

MF 510, Diesel, Gear, 12' Rigid,
4R30.....\$7,500

MF 760, V8 Diesel, Hydro, Chopper, 2850
Hours, 15' Flex.....\$12,500

JD 6600, Diesel, Variable Speed, 2800
hrs., w/15 ft. Platform.....\$7,500

JD 7700, Diesel, Hydro, 3492
Hours.....\$9,500

JD 4400, Diesel, Variable Speed, Straw
Spreader, 2405 Hours.....\$15,000

JD 9500, Hydro, **SOLD**,
2759 Hours.....\$68,000

JD 9500, Hydro, Chopper, **SOLD**,
1721 Hours.....\$77,000

JD 6620 Hydro Spreader, Rear Wheel
Drive, 2750 Hrs.....\$22,500

Good Selection of Used Flex Platforms - Stop in Today, See Our Selection

They take a licking and keep from sticking

Slick poly repels mud and allows the platform to operate next to the ground for those low, hard-to-cut crops. Get the best harvesting advantage in wet, sticky soil conditions. Replace your worn platform shoes today with new John Deere poly-skid shoes. Complete kits available for John Deere 200 and 900 Series Flex-Platforms. Sizes 13 to 30 feet.

■ Predrilled to match skid plates

■ Hammer rivets for quick installation

■ Unique "close fit" hinge design

■ Complete kit includes end skids and wobble box cover

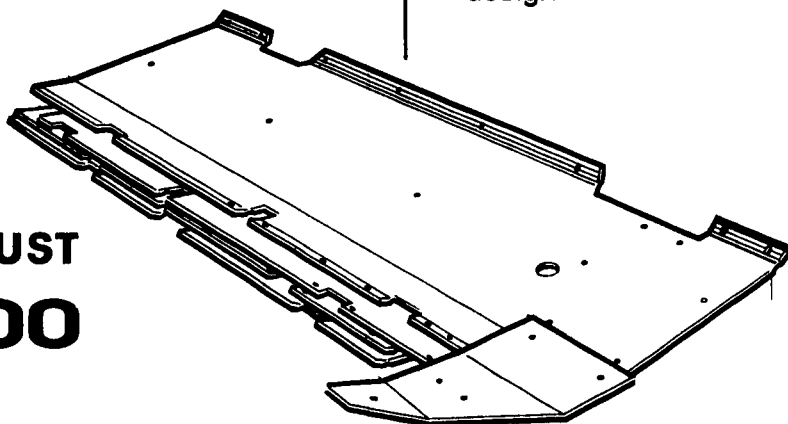

STARTING AT JUST

\$350⁰⁰

Guards

Forged steel for long life. Precise fit to cutterbar to keep your sickle cutting clean.

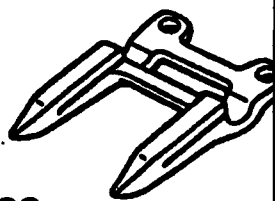

\$6.³⁹

Dura-Lite™ Section

Provides the same features, strength, and cutting performance as the Dura-Cut™ section, yet weighs 33 percent less. Reduces power requirements, stress, and vibration.

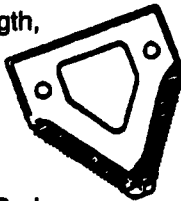

.86¢

Platform Auger Fingers

John Deere field-tested fingers and bearings are surface hardened for shock resistance and long wear.

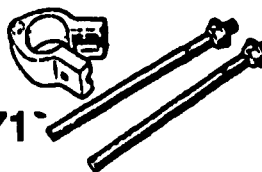

\$3.⁷¹

WE SHIP DAILY

MISCELLANEOUS USED EQUIPMENT

Brady 1680 14 Ft. Flail Shredder...\$3,750

Brillion 15' Flail Shredder.....\$5,750

JD 300 Husker w/ 2R30.....\$10,500

Krause 15 Ft. No-Til Drill.....\$10,500

JD 750, 15 Ft. No-Til Drill.....\$17,500

JD 8300 21x7 Grain Drill.....\$3,650

JD 8300 21x7 Grain Drill.....\$4,250

NH 790 Manure Spreader.....\$2,850

JD 780 Hydro Push Spreader.....\$7,950

JD 780 Hydro Push Spreader.....\$8,500

USED HAY EQUIPMENT

CIH 960 Hay Rake, Like New.....\$2,775

MF 224 Square Baler w/ Chute.....\$5,500

JD 336 Baler w/ JD 30 Ejector.....\$5,175

NH 575 Baler w/ Ejector, Like New.....\$12,900

NH 846 Round Baler.....\$5,500

MF 925 Mower/conditioner.....\$3,250

NH 489 Mower/Conditioner.....\$6,950

NH 495 Mower/Conditioner.....\$4,950

JD 1219 Mower/Conditioner.....\$6,250

USED FORAGE EQUIPMENT

JD 3970 Forage Harvester w/Electric Controls.....\$17,500

JD 3970 Forage Harvester w/Electric Controls.....\$12,500

JD 3970 Forage Harvester w/Electric Controls.....\$11,000

JD 3960 Forage Harvester w/Electric Controls **SOLD**.....\$7,500

JD 5820 SP Forage Harvester.....\$51,500

NH 30 Forage Blower.....\$2,250

Gehl 720 **SOLD** hopper.....\$1,500

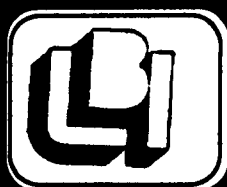

Landis Bros., Inc.

1305 Manheim Pike
Lancaster, PA
717-291-1046

30 Evergreen Rd.
Lebanon, PA
717-228-2650

