

IH hay rake, 5 bar, late model. Woods C-80 rotary mower. NH 469 haybine, \$385. (610)469-9633.

IH & JD Combines and others. Deere Financing. Larry Stalter "The Combine Man" 1-800-248-2151

In-line bale wrappers, for any size silage bales. Self powered, high speed, low maintenance. For more information: Glenn Beidler, (717)539-8993.

IH baler 46 w/thrower for sale. Runs excellent. \$650. (610)367-0347.

DISMANTLING FOR PARTS: Just arrived for parts: IHC 3514 backhoe loader w/good 239 engine and good backhoe assembly for parts.

BALANDA EQUIPMENT
P.O. Box 407 RT 29
Palm, PA 18070.
1-800-322-8030

IH 574, gas, runs excellent, 90% rubber, twin shaft, low hrs., needs paint, \$3,800. 410-833-9091

IH 6R cultivator, good condition. 717/258-6010.

IH 706 gas, WFE, TA, runs good, \$4500. 814/275-3375.

IH 820 flex head, 15' plastic tines, good condition, \$3,200 OBO. (717)627-2023.

JD Model 315 Minimum Tillage Disc 14'. New Condition, \$4000; JD Model 494A 4R Corn Planter, \$250; AC 4 30" Row No-Till Planter Model 600 Frame w/Dry Fertilizer Boxes, \$1000. (410)275-8149.

JD's FOR SALE: (3) un-styled A, (1) on skeleton wheels; 830, electric. 717-222-4432 evenings.

John Deere 45 combine, dual drive wheels, garage kept. Bucks County. (215)822-9638.

Kelly Ryan bagger, 1 year old, like new, BO. Badger 1050 silage wagon, 1 year old, \$6,000. 14' Badger 950 \$4,000. Kaston tandem \$3,000. MF 850 combine, excellent condition, BO F950 Ford tandem grain truck (301)694-8624.

Lancaster Farming, Saturday, July 2, 1994-D17

JD style B w/2R cultivators; 2 elevators; 1 metal flat wagon; NI 323 1R corn picker; drag elevator; 250 bu. gravity wagon; NI 4 bar rake; Ariens 7hp rotor tiller. 215-249-3003 after 7PM.

John Deere B, early styled, on rubber with spoke front wheels, new rings, \$1500, Evenings 717/458-4560 or 717/458-5043.

JD Tractors: 530 3Pt., Good Condition. 620 3Pt., Nice Original Condition. 630 3Pt., Good Rubber, Solid Tractor. 720 Gas Good Condition, Straight Tin, New Rubber. 730 Diesel, Direct Start, WF End, Fenders, 3Pt., Good Rubber, Nice Tractor. Call Mornings or Weekends (304)735-5710.



ANIMAL HOUSING EXPO

A show for Northeast livestock, dairy and poultry producers

PENNSTATE College of Agricultural Sciences Cooperative Extension

July 12-13, 1994
Lebanon Fairgrounds
Lebanon, PA

Sponsored by Penn State Cooperative Extension Agribusiness

Horst Running Gears Come from Binkley & Hurst Bros. Inc. A Very Important Standard Feature On All Horst Wagons From 8-10-12-13 and 14 Ton Is This Unique Roller Bearing Steering.

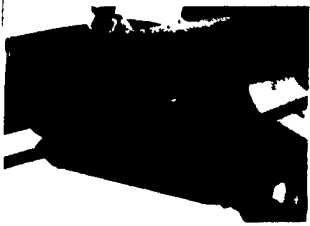

On all model wagons the steering assemblies are mounted on Taper Roller Bearings. Over 20 years field service has proven that this feature plus ball-in socket tie rod ends assures long life and no sway trailing.



Horst No. 140 8 Ton Farm Wagon

- Model 140 - The Ideal Hay Wagon
- Suitable for Bale Thrower Racks
- Flat Rocks, Medium Size Grain Bins And Will Also Serve As A Medium Duty Forage Wagon.

14 Ton In Stock With Rocking Bolster, Also 18 Ton w/Brakes Available With Order

Horst Wagons... with the Honest Ton Rating and No Sway Trailing!

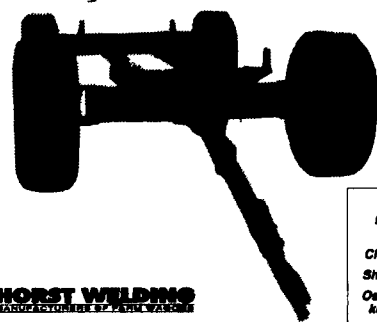

Wide Track for Extra Stability
Rugged Formed Channel Steel Frame
Short Turning Radius
Oscillating Front Axle keeps load level on uneven ground

HORST WELDING MANUFACTURERS OF PAH WAGONS

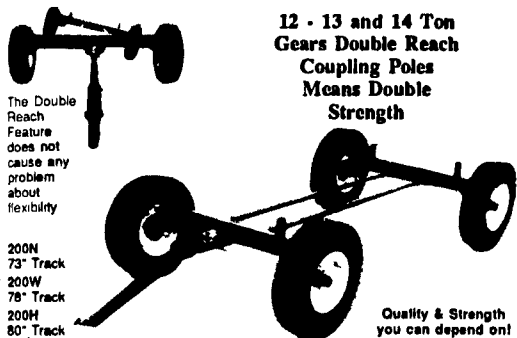

12 - 13 and 14 Ton Gears Double Reach Coupling Poles Means Double Strength

The Double Reach Feature does not cause any problem about flexibility

200M 73" Track
200W 78" Track
200H 80" Track

Quality & Strength you can depend on!

Always Call Binkley & Hurst Bros. For All Your Running Gear Needs



Up To 1000 Cu. Ft.
A-Dump Wagon Can Replace Up To 2 Forage Boxes

RICHARDTON DUMP BOXES



See Us for All Sizes Available

GOOD HAY TOOLS COME FROM BINKLEY & HURST BROS., INC... We Have:

- New & Used Mower Conditioners
- New & Used Forage Boxes - A Good Selection
- New Round Balers
- New Square Balers & Bale Wagons w/Order
- Hay Rakes
- Pequea Hay Toppers w/Special Order
- New Case IH 8720 Forage Harvester With Hay Pickup Ready To Chop
- Forage Blowers
- Forage Boxes, Dump Wagons

New Harlo Ford Diesel 6000 Lb. Lift With Side Shifter Forklift



30% Mast Tilt For Transport
Discounted For Demo
Get A Super Deal!



Rhino disc mowers feature an easy access cutterbar. The innovative design of the cutterbar allows access to the disc spindle shaft and gear module without disassembly of the entire cutterbar, reducing maintenance costs and downtime. The hardened rock guards are designed to help protect the entire leading edge of the cutterbar from damage and, along with the skid shoes, are easily replaceable. A heavy-duty CAT III & Cat II offset three-point hitch made of 4"x6" thick wall tubing is standard to provide dependable service. A safety breakaway system is built in to provide mainframe protection against sudden impacts when mowing. With 5' of blade overlap and blade tip speed of 15,814 FPM, Rhino disc mowers provide a clean, smooth cut. Rugged construction and high performance are two reasons Rhine disc mowers are the ideal choice for fast, efficient grass mowing.



ROTARY 3 PT. DISC MOWERS IN STOCK RHINO AND GEHL BRANDS

GET ONE NOW!

SMUCKER

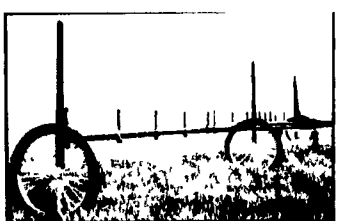

New and Proven

Revolutionary new concept in weed wipers. Check out the sponge-type unit from Smucker. Minimal dripping, maximum contact and quality construction make the Smucker weed wipers worth checking out! We Sold Many and Work Well!

Closed Monday, July 4th

Check Out This New Cultivator

At **40% OFF**
New Minimum-Till 3 Pt. Cultivator Set-Up & Ready To Work On Your Farm!

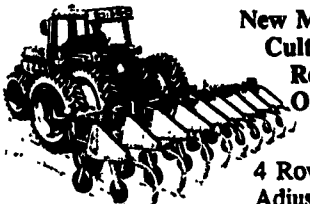

4 Row 36"-40" Adjustable Row Spacing With Cushion Clamp Shanks, Cat II or III 3 Pt. Hitch

WE HAVE ONLY ONE IN STOCK!

Price \$3,850
Less \$1,925 Cash And You Haul, FOB No Trade Price!

2"x24 FT. LONG-WIDE HANDLE RATCHET STRAPS

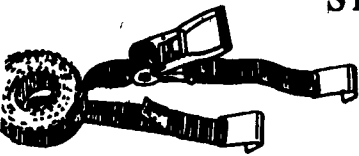

10,000# MBR

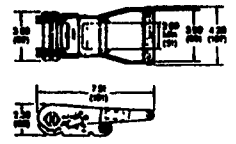

Handle is designed for convenient operation when wearing gloves. In stock. See Binkley & Hurst Bros Parts Dept. Now! We Ship UPS, Federal Express. Please Call For All Your Special Strapping Needs.

ORDER QUANTITY					
1-4	5-9	10-24	25-49	50-99	100+
\$25.50 Each	\$25.00 Each	\$23.00 Each	\$22.00 Each	\$21.00 Each	\$20.00 Each

ECONOMY MOWERS



Quality At Reasonable Prices!

IN STOCK
5 Foot 6 Foot
7 Foot
Check w/Us On 8 Foot Models

STOP IN FOR QUALITY!

GO WITH THE #1... The Old Reliable Your Best Buy In Grain Handling

McCurdy

- Before You Buy, Check With Us
- Most Sizes In Stock For Quick Service & Availability
- We Sell In Volume

SIZES IN STOCK:
190 BIN
230 BIN
275 BIN
325 BIN

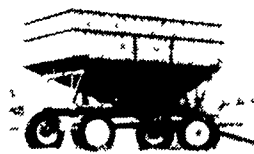

Model 190

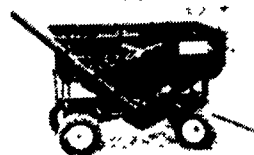

Model 230

Running Gears With 5 Year Axle Warranty

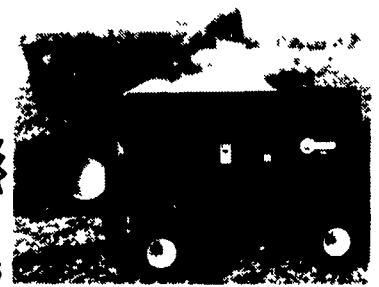

Model 275

Model 325

Super Deals At Binkley & Hurst Bros. On Dumping Station Conveyor Box Blower Feeders, Speed Up Your Silo Filling Operation By Seeing Binkley & Hurst Bros. Now!



SEE US FOR ALL YOUR PARTS NEEDS- WE STOCK A LOT & CAN ORDER FOR QUICK DELIVERY!

See Binkley & Hurst for a Good Rotary! DEFEND AGAINST WEEDS



3400 Series Toolbar Rotary Hoe

The only good weed is a dead weed, and the Weed-it Family is your first defense. Our Rotary Hoes and Cultivators reduce herbicide costs while shattering crust and aerating the soil at high speeds. Protect your fields. See Binkley & Hurst Soon!



SEE US FOR ALL YOUR PARTS NEEDS- WE STOCK A LOT & CAN ORDER FOR QUICK DELIVERY!

BUMPER TRAILER & PINTLE HOOKUP TRAILERS

JUNE PART DEPT SPECIAL DICKY-John HARVEST-HAND Portable Grain Moisture Tester

Harvest-Hand measures the moisture content of your grain automatically. It weighs the sample and automatically compensates for grain temperature. Just turn the unit ON, select the desired grain, and slowly pour your grain into the test cell. The measurement cycle begins automatically when the proper weight of grain has entered the cell. Read the direct temperature-compensated moisture content when display stops flashing.

Direct readings for these 12 grains:

- corn
- soybeans
- wheat
- milo
- oats
- barley
- sunflowers
- canola
- rice
- popcorn
- millet
- rye



Sale Price \$197.50

Conversion charts available for other grains.

BINKLEY-HURST BROS. INC.

(717) 626-4705

133 Rothville Station Rd. Lititz, PA 17453
1-800-IT PAYS YOU

