

35 TRUCKS & TRAILERS

'68 Int. 6190 20' stake body, good condition, \$1250. 215-323-5617.

'73 Mack Tandem w/ Wetline, 237 Engine w/ Recent Engine Overhaul, \$7500. (609)935-0348.

74 R Model Mack, 237, 300 Block, 5 Speed, Jake Brake, PS, 75% Rubber, Body Excellent and Mechanically Sound, Great Work Truck. (717)436-5454.

'77 Ford F700, 6 ton boom, and flatbed dump, 391, 5 speed, 10.00-20, \$5000; 69L diesel, rebuilt motor, less pump, \$1500; Lift gate, vg, \$600; 1977 35 ton lo-boy wetline, drop deck, 18' bed, 10' rear deck, \$6000; Mack R model, 237, 5 speed, 38R, wetline, 10.00-22, 90% recap, \$5800; Baker forklift, 5000 lb, \$2500. 610-582-2625 after 6PM.

'79 Int. 4070B tractor, '71 Gilmore 26' dump trailer, \$12,000. (717)867-1689 after 5pm.

'84 Ford F250, 4x4, 460, pickup w/dump bed, 8600 GVW, runs great. (610)932-8999.

'84 Mack MH cabover, 440, V-8, good condition. Wayne County. (717)253-2042.

'86 Chevy Scottsdale C10, 5 passenger Suburban, 350 auto, PB, PS, cruise, tilt, air, AM-FM cassette stereo, red & tan, 62,000 miles, local 1 owner, excellent condition, \$7,800 717-733-2873

MOTORS
New & Rebuilt
350, 366,
427, 454
6.2 Diesels
Rebuilt & Used
Will Install
Roll Back Service
(at cost)
717-762-6415

Ford Super Cab Rear Seat Lift Kit

Raises seat 4" for more comfort includes all hardware & instructions.
\$79.95 Free Shipping! PA Residents Add \$4.80 Tax
Weaver Distributing
1-800-WEAVER-D
RD 2 Box 47D
Frederickburg, PA 17028

E-TOWN DODGE
1992 Dodge 350 Cummins Diesel Pickup, Dual Wheel, 5 Speed, 2WD, Air, Tilt, 58K
1992 Dodge W250, 19K, 5 Speed, 3/4 Ton, Gas, 1 Owner
1994 Dodge Full Size Pick Ups In Stock
ASK FOR MILTON HESS
Certified Truck Specialist
717-367-6644
717-653-6667
Elizabethtown, PA

TRUCK CRAFT

PICKUP INSERT DUMPER
For FREE brochure, call toll free 24 hr.
1-800-755-3867

TURBOCHARGER SYSTEM
"Bulldozer"

Ford 7.3L/6.9L Diesel Pickup & Navistar S Series Trucks
Hypermax ENGINEERING, INC.
The HYPERMAX PULSE TURBOCHARGER SYSTEM utilizes the high pressure exhaust pulses to achieve faster "off idle" engine acceleration and vastly improves throttle response. This response feature is accomplished without the use of a wastegate, which detracts from performance anywhere but at low engine speeds, due to its inherent high exhaust back pressure.
Ask For "Wastegate Facts of Life"
PENN DIESEL SERVICE CO.
337 N. Fairville Ave., Harrisburg, PA 17112
(717) 545-4207 (800) 535-2913

WHY?
...is Your Competition Driving Isuzu Trucks?
Less Down Time & Increased Profits!
Isn't It Time For An Isuzu For Your Business?
1994 ISUZU NPR
11,050 GVW, diesel, auto trans, AM/FM cassette, power steering & brakes, tilt steering wheel, 33 gal fuel tank #3148
11 IN STOCK!

\$19,992
Plus Tax & Tags
717-354-4901
New Holland
FORD • ISUZU TRUCK
Rte 23, New Holland, PA

1978 Budd refrigerated trailer, 42' long, Thermo-King unit, excellent floor and condition.
\$5,000
(717) 648-0094

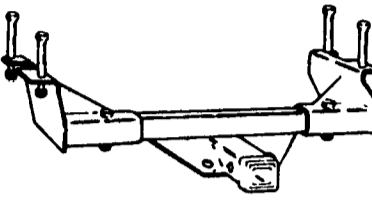
TIRONIE'S TARPS
717/584-2928
1/800/874-2928













1991 Ravens 40' Frameless Dump 10'2" Spread On Air, 8 Aluminum Wheels, 66" Sides, Towmotor Floor, Rollover Repaired, Needs Tarp.
\$25,000
717-275-5766

SEE US FOR YOUR BOLT ON RECEIVER HITCHES
Heavy Duty Class 4
10,000 LB. MTGW
1,000 Lb. Tongue Wt.
W/WT Distributing

ALSO SEE US for your Axle parts & complete assemblies 2,000 - 22,500 LB.
Axles & Suspensions
Metal Trailer Components
Lights & Electrical supplies
Brakes, Tires & Wheels
Jacks, Couplers & Hitches
Hardwood Accessories & much more
Buy Where the Quality is #1 at the right price

Ask For Dean At:
BINKLEY & HURST BROS. INC.
133 Rothsville Station Rd. • Litz, PA 17543
717-626-4705

GOOD USED TRUCKS

1991 FORD F350 Dually, Crew Cab, 7.3 Diesel, AT, Loaded #P1842 \$20,399

1992 FORD EXPLORER 4x4 XLT AT, Luggage Rack, Performance Axle, Trailer Tow, Red #P1844 \$21,999
SHEEY LEBANON
FORD • MERCURY • LINCOLN
20TH & CUMBERLAND STS • RT 422 WEST

 1985 INTERNATIONAL S2500, 350 Cummins, 9 Speed, RA472 Rears, PS, AC, One Owner, New Paint, Very Clean \$13,900	 1987 INTERNATIONAL 9670 TT, 350 Cummins, RT11609, SQ1000 Rears, PS, 11R 24.5 On Budds, New Paint, Very Good \$13,900	 1984 MACK MIDLINER 20' Van, 175 Engine, 5 Speed, PS, Disc Wheels, 32,000 GVW, 10.00x20 Radials, Clean Unit \$7,500
 1984 FORD F600 Cab & Chassis, 370 Gas, 4 Speed, PS, Low Mileage, 19,700 GVW, Good Buy \$4,900	 1980 INTERNATIONAL 2275, SA, TT, 6-71 Detroit, RT1110 Trans., 23,000 Rear, PS, 22.5 Radials, Cheap Horse \$6,900	 1979 INTERNATIONAL S2275 TT 6V92T Silver, 9 Speed, RA355 Rears, PS, New Paint, Good Value \$6,900
 1986 FREIGHTLINER TT 3406B, 350 HP, RT12609, DS381, PS, 22.5 Low Profiles, Runs Well \$7,900	 1981 MACK F686 SA, TT, 300 Mack, RT11509, 23,000 Rear, Budds, PS, Good Value \$4,500	 (2) 1985 S1624 INTERNATIONAL 12' Van, 6.9 V8 Diesel, 4 Speed, PS, 19,200 GVW, Low Mileage, Your Choice \$6,900 ea.
 1975 FORD F750, Crew Cab, 361 V8, AT, Air Brakes, PS, Aux. Air Comp., 32,000 Miles, Utility Body, Many Uses Only \$3,000	 (10) USED VAN BODIES From 11' to 24', Some Insulated, Priced From \$300 to \$1500	 1986 GMC GENERAL TT, 400BC Cummins, RT014613, SQ100 Rears, 36" Sleeper, PS, Good Value At \$12,900

FIRESTONE MOTORS, INC.
330 S. THIRD ST. • LEMOYNE, PA 17043 • (717) 763-7721