

12-31, 1993 - 10% OFF ENTIRE INVENTORY

10% OFF On Every Item On This Page

CHRISTMAS EVE, DEC. 24, AND
NEW YEAR'S EVE, DEC. 31
CHRISTMAS AND NEW YEAR'S DAY



T
e
RS
90°-
00
ric, 190°
66°00
ric, 210°
57°00
ic, 210°
79°00



COLD WATER WASHERS

- E20-10 1,000 PSI 1 1/2 HP Electric \$519⁰⁰
- E25-14, 1400 PSI, 2 1/2 HP Electric \$636⁰⁰
- E30-15, 1500 PSI, 3 HP Electric \$675⁰⁰
- B30-15, 1500 PSI, 5 HP, Briggs \$714⁰⁰
- HC 35-17, 1700 PSI 5 HP Kohler Command \$846⁰⁰

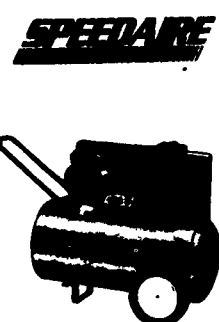

SPEEDAIRE

32355
2 HP,
20 Gal. Tank
With
Air Hose
SALE
\$388⁰⁰



HEAVY DUTY LUBES

End-Of-Year Sale



SUPREME XHD #30 OIL
\$240⁰⁰
Less 10% Sale
103155

1540 DIESEALL OIL
\$250⁰⁰
Less 10% Sale
101555



5 Gallon Pail Special



SUPREME XHD #30 OIL
\$28⁵⁰
Less 10% Sale

1540 DIESEALL OIL
\$31¹⁵
Less 10% Sale

BLUE HYDRAULIC PLUS OIL
\$24⁹⁵
Less 10% Sale

UNIVERSAL TRACTOR HYDROSTATIC FLUID
\$29⁵⁰
Less 10% Sale

CASH & CARRY WHILE SUPPLY LASTS - NO RAINCHECKS

DRYDENE GREASES

HEAVY DUTY LITHIUM E.P. All Purpose Grease
Case of 10
\$13⁹⁵

PYROPLEX E.P.

High Temperature (500° F) For Disc Brakes, Wheel Bearings, Chassis. All Purpose Grease

Case of 10
\$18⁹⁵

ic, 190°
66°00
ic, 210°
57°00
ic, 210°
79°00

ALL



STEP & EXTENSION LADDERS - Wood • Aluminum • Fiberglass



50 - ALUMINUM RAGES & RANKS

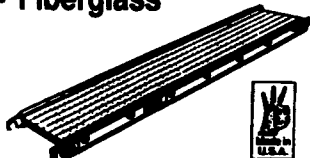

TA
PRESS
t Set
95

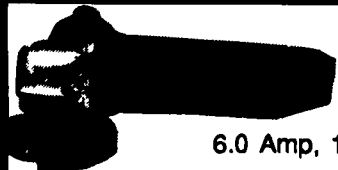

SKIL

6.0 Amp, 12000 RPM

PROFESSIONAL DISC GRINDER

Model 9611 Includes: Wheel guard, flange kit, side handle, grinding wheel, locknut wrench

\$74⁹⁵

716

TOOL BOX
24" Rough (Flat Top)

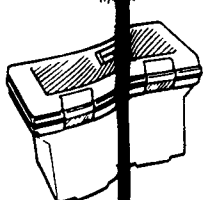

\$21⁹⁵

PAINT DEPT. SPECIAL PLA9128 PAINT THINNER
Gal. **\$2.49**

975 DUCT TAPE 60 yd.
\$2.69

8600827 BEATS NAILS
10.5 oz. **89¢**

8041691 Barn & Fence Paint
gal. **\$14⁹⁵**

8600694 Silicone Caulk Tubes
10.5 oz. **\$3.75**

WISE-GRIP Two Great Tools

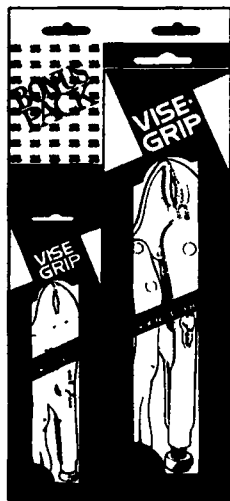

614™ VISE GRIP GIFT SET®

5WR®-5"
And
10WR®-10"
\$13⁹⁹

DURACELL® Batteries

SPECIAL SALE Saver Pack D4, C4, AA8, 9V2

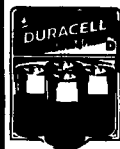

Special Price MN1300B4 **\$4.35**



Special Price MN1400B4 **\$4.35**



Special Price MN1500B8 **\$5.18**



Special Price MN1604B2 **\$4.60**

HEAVY DUTY BARN SCRAPER

• 2218SS 18" **\$20⁹⁵**

• 2224SS 24" **\$21⁹⁵**

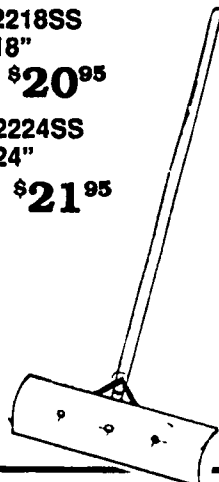

SOCKET SET

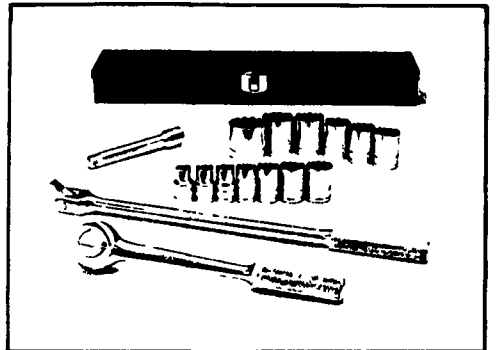

16 PIECE PROFESSIONAL SK4116 \$69⁹⁵

WIESE BRAND TILLAGE AND CUTTING PARTS

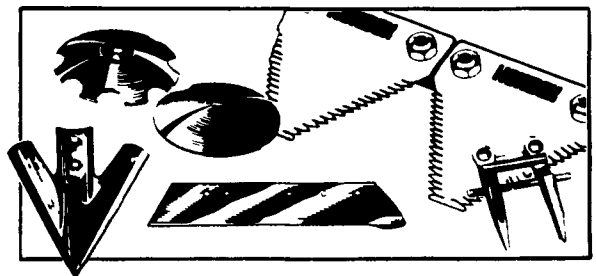

24" FANS

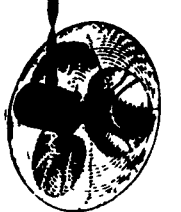

1/4 HP 2 Speed F14224HB

SALE \$154⁰⁰

FARM DUTY MOTORS

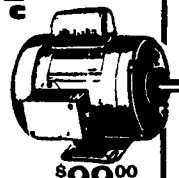

- 4K036 - 1/4 HP **\$99⁰⁰**
- 4K047 - 1 HP **\$109⁰⁰**
- 4K040 - 1 1/2 HP **\$139⁰⁰**

EXACT MASTER PROFESSIONAL LEVEL

MASON'S LEVEL - MAHOGANY



MPO-48 **\$38⁹⁵**

FREE RESIDENTS - FREE ANCOOKIES!



BROOMS - For Heavy And Coarse Sweeping



18" - No. H7418H - **\$18⁹⁵**

24" - No. H7424H - **\$26⁹⁵**

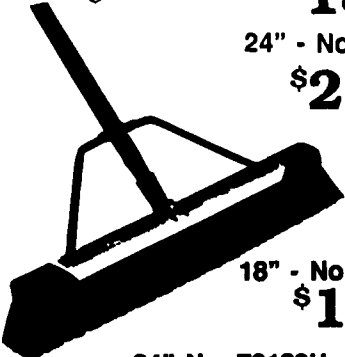

18" - No. 70182H - **\$11⁹⁹**

24" No. 70183H **\$16⁹⁵**

RATCHET-STYLE LOAD HUGGERS



LA025 - 2"x27" 10,000 Lb. **\$24⁴⁵**

HITCH PINS

\$1.95



WD-40
Gallon **\$11⁹⁵**

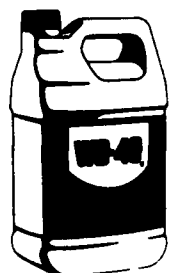

With **FREE** Sprayer



Werner INC.

50 Woodcorner Rd.
Lititz, PA 17543
1 Mi. West Of Ephrata
717-738-7350