

Don't Miss The Patz Display At AG PROGRESS DAYS... Located on East 5th Street

**Low Rate
Financing
Up To 48 Months**

Mixing T.M.R. the Way You Want

Trailer
mounted
auger
mixers

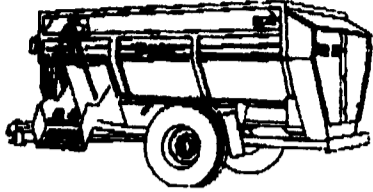

Stationary
auger
mixers

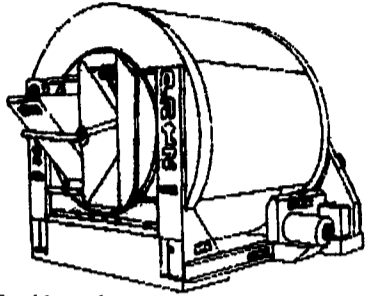
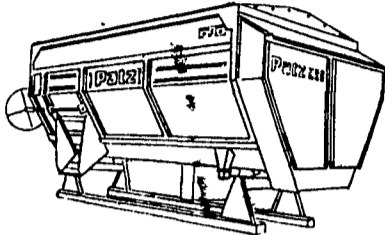

Tumble mixers

- Open-Top Mixers
- Tumble Mixers

Model 8820 Ring- drive dual- auger silo unloader

NEW!

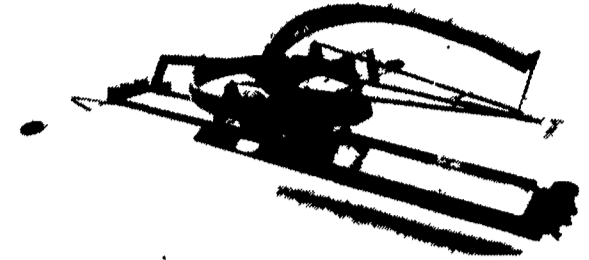

Model 8810 Dual-auger center- drive silo unloader with Patz quality

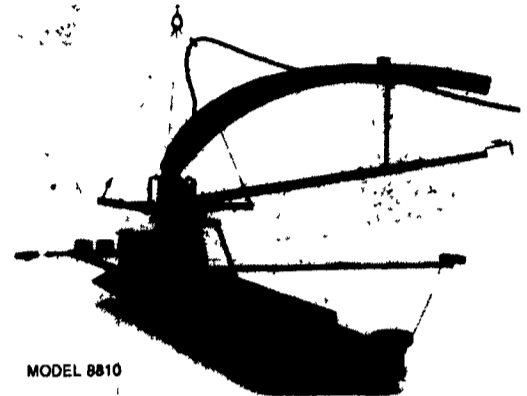

MODEL 8810

Model 8800 Dual-auger surface- drive silo unloader with Patz quality

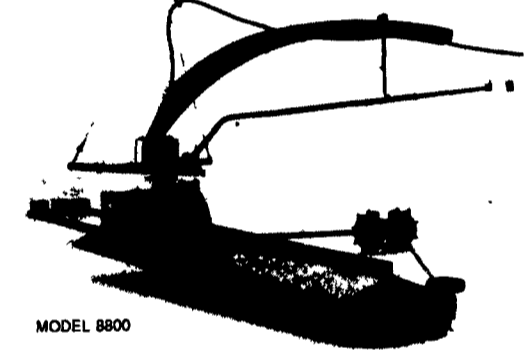

MODEL 8800

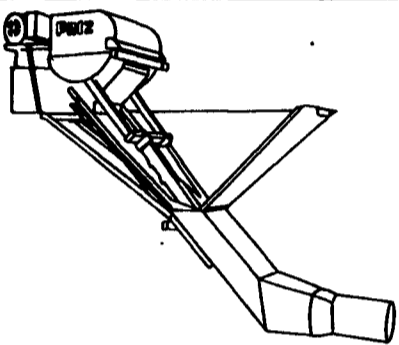

Model 1512 Manure Pump

For slurry
manure



Proven-Dependable Gutter Cleaner

**New Patz
Chain Now
Warranted
For 15 Years!**

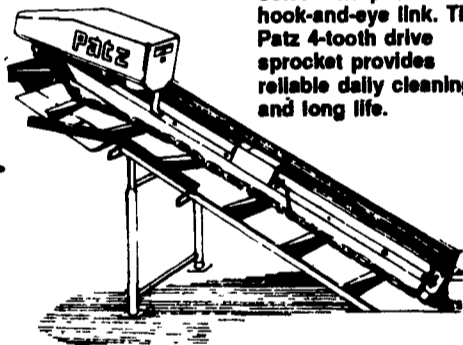

Select and proven Patz hook-and-eye link. The Patz 4-tooth drive sprocket provides reliable daily cleaning and long life.

Bale Chopping Made Easy!



**Affordable
Financing**

Model RD-820 Ring- drive silo unloader

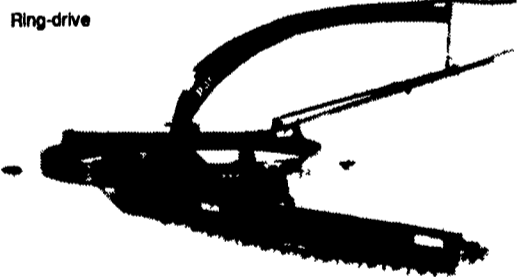

Ring-drive

Model 98C Surface- drive silo unloader

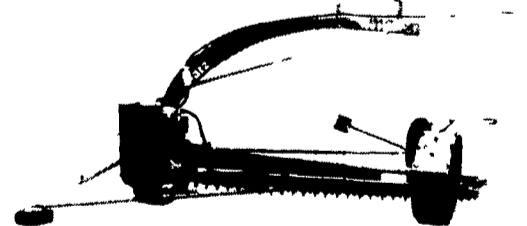

Patz SEE YOUR NEAREST DEALER

ALEXANDRIA
MAX ISENBERG
814-669-4027

BELLEVILLE
LUCAS BARN EQ.
814-383-2806

LEBANON
CEDAR CREST
EQUIPMENT
717-270-6600

ORANGEVILLE
FRANKLIN D. HESS
FARM EQUIPMENT
717-925-6939

SOMERSET
GROVE EQUIP. SALES
Mark Knepper
Cliff Lynn
814-445-6306

WESTMINSTER, MD
C&G FARM
AUTOMATION
Carrol & George
Gesell
410-775-7300
410-848-3622

DISTRICT
MANAGER
Agri Bee Inc.
James Bilski, Pres.
814-696-9447

BALLY
LONGACRE
ELECTRIC
215-845-2261

BELLEVILLE
MILLER-LAKE Inc.
717-935-2335

MECHANICSBURG
JOHN JONES
717-766-8582

QUARRYVILLE
UNICORN FARM
SERVICE
James E. Landis
717-786-4158

HAGERSTOWN, MD
TRI-STATE
FARM AUTOMATION
301-416-7340

WHITEFORD, MD
ENFIELD EQUIP.
410-838-0480

BEDFORD
BENCE'S FARM EQUIP.
814-623-8801

HOP BOTTOM
LENOX FARM SUPPLY
Kurt Kulick
717-289-4349

MIFFLINTOWN
ZUG FARM &
DAIRY EQUIPMENT
717-463-2606

SHIPPENSBURG
WITMER EQUIPMENT
SERVICE
717-532-6139

KENNEDYVILLE, MD
PINDER SERVICE CO.
410-778-0799

POUND, WI
PATZ SALES,
INC.
414-897-2251



Gold Sponsor