

**POLE BUILDINGS**  
 Top Quality Materials & Workmanship  
 Please call us before signing with anyone!  
 We WILL Save You Money  
**TIMBERLINE BUILDINGS**  
 1-800-842-0276

**STEEL BUILDINGS.**  
 Factory sale.  
 24x30, 40x75, 50x90, 60x100.  
 Very limited supplies. Serious buyers only.  
**Speedwell Constr.**  
 717-665-6861

**Fiberglass WALLBOARD PANEL**  
 FOR Milkrooms, Parlors, Feed Mangers

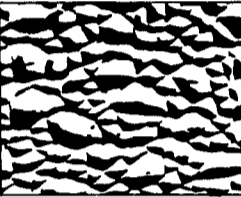

Cap Division Bar Inside Corner and Cove

White & Colors  
 4'x8' - 4'x9' - 4'x10'  
 .090 Save 50%  
**45¢-55¢/sq. ft.**

ALSO: Full Line Of Roofing & Siding  
 Large Inventory In Stock!  
 Call For Low Prices!

**A.B. MARTIN ROOFING**  
 Ephrata, PA 17522  
 (717) 354-5076  
 Pennyan, NY 14527  
 (315) 536-0944

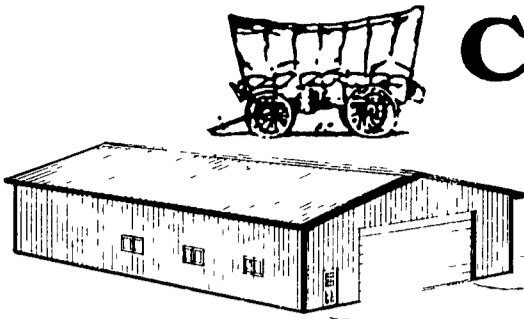

# Conestoga Building Supply

RESIDENTIAL GARAGES

- \* POLE BUILDINGS
- \* In House, Professional Engineering For Design And Prints
- \* Concept To Completion
- \* Sealed Prints for PA, NJ, DE, MD

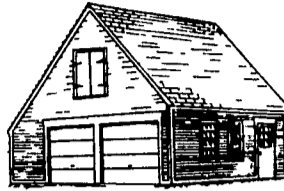
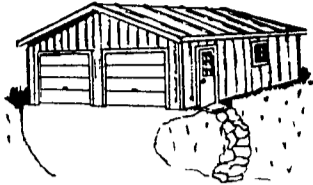

\* NOW AVAILABLE

Storage Sheds

**\$33/sq.**

\*29 Gauge Galvanized Steel

CALL NOW FOR A FREE ESTIMATE OR FOR A FREE BROCHURE

1-800-544-9464

717-354-2613

## Roofing & Siding

Prices Per Sheet 36" Coverage

30 Pc. 12' Gray	\$12.92
11 Pc. 8' Gray	\$8.61
21 Pc. 13' White	\$14.95
22 Pc. 10' Stone	\$10.77
185 Pc. 18' White	\$21.60
220 Pc. 20'2" Tan	\$23.90
27 Pc. 12' Black	\$11.00
82 Pc. 12' Galvanized	\$10.80
100 Pc. 10' Galvanized	\$9.00
100 Pc. 14' Galvanized	\$12.60
110 Pc. 16' Galvanized	\$14.40
100 Pc. 10' Brown 32"	\$11.00
26 Pc. 26 Gauge Blue 20'6"	\$29.00
37 Pc. 20' 3" Brown	\$23.90
70 Pc. Ivory 20'2"	\$23.00
100 Pc. Gable Trim White or Green	\$4.50

This Is A Partial List  
 Call For Products & Sizes

**A.B. MARTIN ROOFING**  
 Roofing • Siding & Supplies  
 150 Slate Road, Ephrata, PA 17522  
 (215) 445-6885 (717) 354-5076

## 5 GRAIN EQUIPMENT

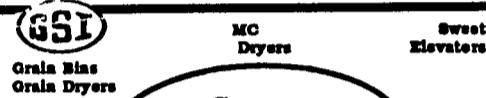

**Sones Grain Systems**  
 Jim & John

Check Our Prices Before You Order  
 We Personally Install Everything We Sell  
 R.D. #1, Box 417 Muncy, PA 17756  
 717-584-2282

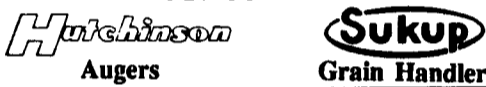

## WE INSTALL NEW & USED GRAIN EQUIPMENT

Elevator Legs Feed Bin Repairs  
 Augers New Blower Pipe  
 Portable Welding Aluminum Welding  
 Custom Built Trailers  
**STOLTZFUS WELDING & REPAIR**

76 S. Vintage Rd.  
 Paradise, PA 17562  
 Call 717-442-9148 6:30-7:00 a.m.

## 5 GRAIN EQUIPMENT

## Do You Recognize This Grain Facility?

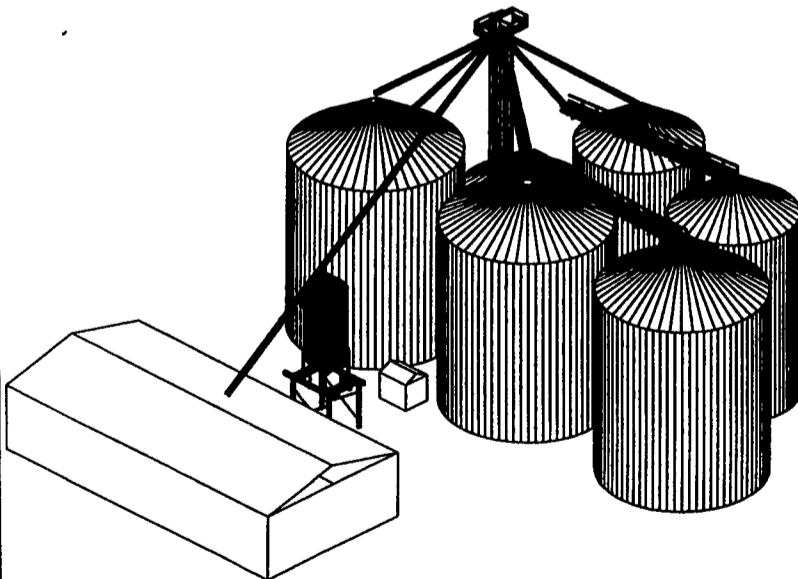

The above is D.E. HORN & CO. of Red Lion, PA and was designed, built and is serviced by us.

We offer complete services for large farm and commercial grain handling & drying including:

3D Drawings To Scale, Sales & Construction, Service & Large Parts Inventory, Quick & Inexpensive Crane Service (12 thru 35 Ton with 165' reach)

Call us for a quick response to your needs and to go over your system BEFORE HARVEST.

**LOUCKS GRAIN EQUIPMENT, INC.**

R.D. #12, Box 307, York, PA 17406

717-755-2868 (Fax 717-755-2869)

REPAIRS AND REMODELING  
 UTILITY SHEDS, GARAGES IN CEDAR & BOARD BATTEN

## Groffdale Barns

General Construction & Restoration

MOSES B RIEHL  
 717 687 8350

745 STRASBURG PIKE  
 STRASBURG, PA 17579

## METAL SIDING & ROOFING TRUCKLOAD SALE

- \$3.00 Per Sq. Off Regular Price On Top Of The Line Painted 29 Ga. Steel. Prices As Low As \$38/Sq. Or \$1.20 Per Lineal Ft. Delivered Anywhere
- We Stock A Full Line Of Pole Building Parts & Accessories

## CALN Door & Supply

Todd Rd., Honey Brook  
 215-384-5942

215-384-5943 FAX

Call For Special Truck Load Pricing

**Leon H. Martin Construction**  
 Specializing in New & Used Grain Tanks, Built and Dismantled  
 820 Little Mountain Road  
 Myerstown, PA 17067  
 (717) 933-8287

## 6 DAIRY EQUIPMENT

**take a closer look!**



there's just no substitute for a HiPerForm!



**MARTIN'S REFRIGERATION, INC.**  
 Phone (717) 352-2783  
 Sales & Service

**SMUCKER'S SALES & SERVICE, INC.**  
 RD #2, Box 21 New Holland PA 17557  
 (717) 354-4158

Authorized Dealer Specializing In LISTER And Also PETER Diesel Engines

TS2/TS3 AIR-COOLED DIESELS 1 1/2 to 132 H.P.

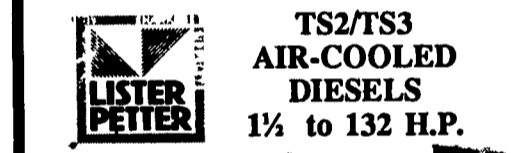

LISTER AIR-COOLED  
 Ask About Diesel And Bulk Tanks - Completely Installed

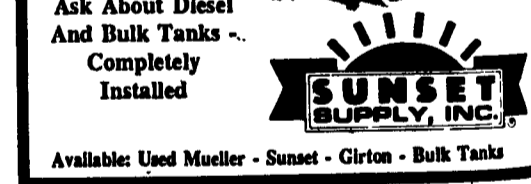

Available: Used Mueller - Sunset - Girton - Bulk Tanks

## THIS WEEK'S SPECIAL

**ELEVATED CALF STALLS**



Special Pricing On Most Parts! (Some Shop Worn)  
 Example: Twin Front \$5.00 ea. cash

