



JOHANNING'S

Family Store

"Take Quality Home"

HOLIDAY GIFT SALE



2460 New Holland Pike, Lancaster, PA 17601
 1/4 Mile West of Meadowbrook Farmers Market, Rt. 23, Leola
 1-800-369-3736 (717) 656-3700 or (717) 291-4420
SALE GOOD THRU DECEMBER 21, 1991

HOURS:
 Mon.-Fri.
 9 AM - 9 PM
 Sat.
 8 AM - 5 PM

ARCTIC FLAME™ HEATERS

By LAWN BOY



35,000 & 55,000 BTU's - Lightweight Compact hand-portable forced air heater. Perfect for garages and workshops. Uses inexpensive kerosene.

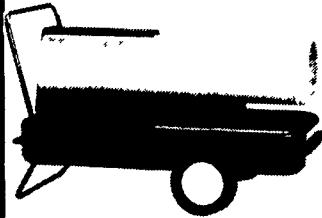

150,000 BTU's - Instant, easily portable forced air heat. Comfort at your fingertips. Simply fill tank with kerosene or #1 fuel oil and plug into any 115V grounded outlet where adequate ventilation is available. Runs 15 hours on one filling. Automatic shut-off control standard. ARL Listed. Optional UL Listed thermostat available.

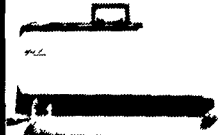

150,000 BTU LP Heater - This liquid propane fueled heater is ruggedly built for larger spaces such as warehouses, barns, factories and construction sites. Comes complete with built-in thermostat and fuel hose, with inline regulator. A.G.A. Certified.

	Reg.	SALE
35,000 BTU.....	\$159.95	\$139.95
55,000 BTU.....	\$189.95	\$169.95
150,000 BTU.....	\$359.95	\$299.00
150,000 BTU, LP Gas.....	\$319.00	\$299.00

FLOATING TANK DE-ICER



SKU 71333
 1500 Watt,
 Plastic,
 No. H-4815

Reg. \$27.99
SALE \$20.99

ACTION PACKER STORAGE CONTAINERS FROM RUBBERMAID

Convenient durable storage organizers. Inter-locking handles. Stackable design. Double wall lid for added strength.

\$14.99 15.5 gallon.
 No. 1171-04-38

\$16.99 24 gallon.
 No. 1172-04-38



CAKE FOIL PAN

Great baking without the clean-up.
 No. 92590 **59¢**

LASAGNA AND ROASTER FOIL LINER PANS

Reusable aluminum foilware. Bake, roast, store, reheat.
 No. 92930, 95836 **97¢**

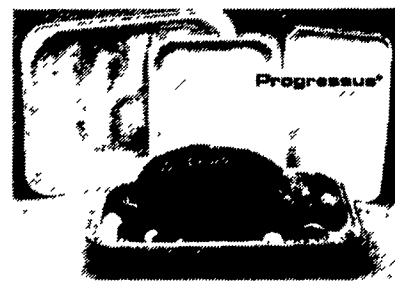

BLACK & DECKER™

4247 4 1/2"

ANGLE GRINDER



SKU 48500

Sugg. Retail \$118.00

- Powerful 510 Amp Motor For Long Life Under Continuous Load
- Ball Bearing Construction For Long Life And Smooth Operation
- Comfortable Paddle Switch With Lock On For Easy Operation

SALE \$74.95

• Full One Year Professional Use Warranty

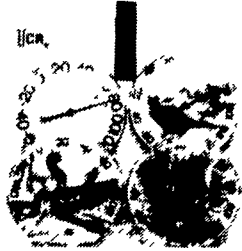

INDOOR/OUTDOOR THERMOMETER
 Read outside and inside temperatures on same F° & C° scales. No. 5326

SALE \$4.29

12" DIAL THERMOMETER
 Bold numbers and graphics allow accurate reading at a distance. Choose from a variety of scenes or plain. No. 4958, 49516, 49512, 49562

SALE \$5.99



CERAMIC HEATER
 Portable-lightweight. Safety tip-over switch. Cabinet stays cool. Heats a 20'x20' room. 5200 BTU. No. 8993-R

SALE \$44.99

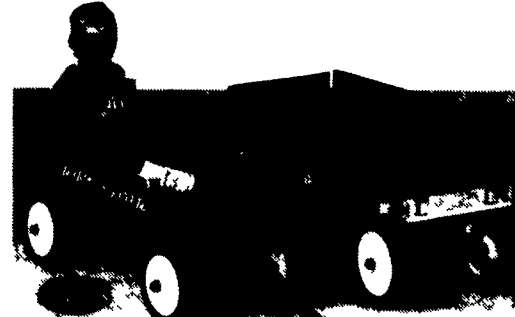

TOWN AND COUNTRY WAGON

Extra-large capacity body crafted of select hardwood. Strong front and rear cleats. Patented Fit-Grip won't pinch small fingers. Easy to assemble. No. 24

WAGON
 A favorite, year after year. Durable all steel construction. Exclusive no-pinch ball joint. Easy to assemble. Ages 2 & up. No. 90

SALE \$29.99

SALE \$49.99

BREYER

BREYER COLLECTIBLES

Let Your Imagination Play.



- AUTHENTIC • DURABLE • COLLECTIBLE
- FINISHED AND DECORATED BY HAND • MADE IN U.S.A.

THE ORIGINAL Mr. Heater

12,000 BTU PROPANE HEATER

Reg. \$49.99

SALE \$43.99

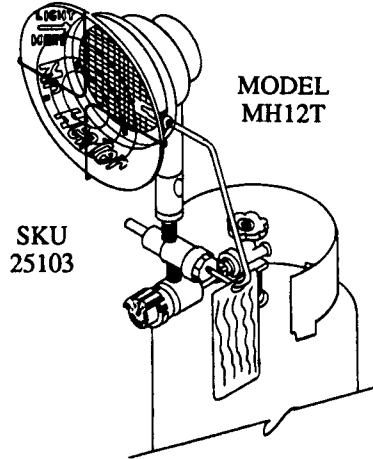

MODEL MH12T

SKU 25103

HUMIDIFIERS

A. TABLETOP HUMIDIFIER/AIR CLEANER

2-speeds. 1000 square foot capacity, 3 gallon output per 24 hours. Replaceable two-stage filter No. 5273

\$38.99

B. CONSOLE HUMIDIFIER

Variable speed control complete with two-stage air cleaner filter. 12 gallon output. Concealed controls for complete furniture styling. No. 4973

\$119.99

C. BACTERIA TREATMENT

Helps prevent bacteria build-up in humidifiers and keeps unit smelling clean. No. 1970

\$3.19

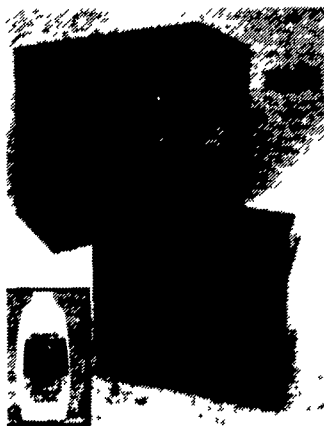

WE SHIP UPS ANYWHERE



Order By Mail Or Telephone
 1-800-369-3736



A. GIANT ANGLE BROOM

Gets in those hard to reach places. With handle. No. 06080

\$4.93

B. PUSH BROOM

Heavy duty cleaning 18" wide palmyra with 4" trim. With handle. No. 09993

\$9.94

C. RECYCLING BINS

Stackable bins make recycling easy and convenient.

\$10.99 16 gallon, No. 804

\$12.99 20 gallon, No. 806