

YEAR END CASH & CARRY SALE - DEC. 20-31

INCLUDING ALL ITEMS ON

BROOMS - For Heavy And Coarse Sweeping



18" - No. 7418 -
\$20.95

24" - No. 7424 -
\$28.95

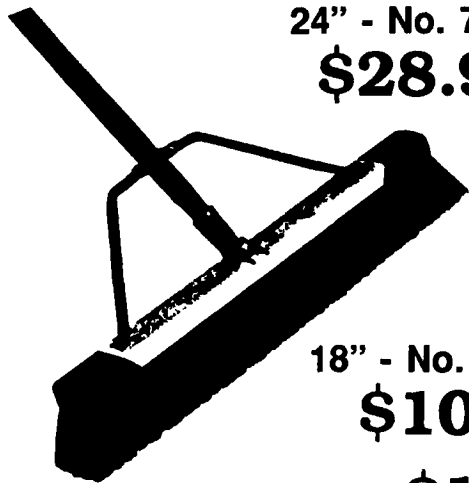

18" - No. 70192H -
\$10.50

24" No. 70193H **\$13.70**

★ **NEW!** ★

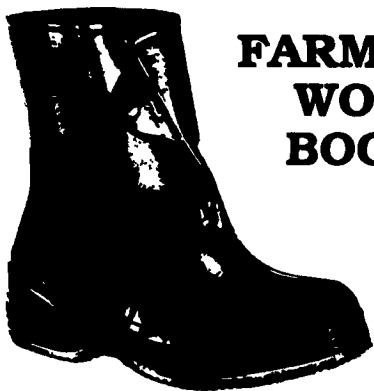

FARM AND WORK BOOTS

LaCrosse 89301 - **\$9.95**

TINGLEY 1400 - **\$14.95**



CLOSING AT 4 PM CHRISTMAS DAY
DEC. 24, AND NEW YEAR'S DAY
DEC. 31
CLOSED: CHRISTMAS DAY
NEW YEAR'S DAY

DRYDENE OIL SALE

- 1030 TEC II **\$18.95** Case
- 1040 TEC II **\$18.95** Case
- 1540 Dieselall **\$22.95** Case
- 30 Supreme..... **\$28.95** 5 Gal. Pall
- 1540 Dieselall **\$29.95** 5 Gal. Pall



COUNCIL

Fine edge tools since 1886

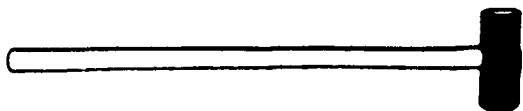

DOUBLE-FACED SLEDGE
R-800 **\$9.45**



POST HOLE DIGGING BAR-
1" Round, TB-6, 17 Lb.,
6' Bar, Tamper Head **\$15.95**

STANLEY

BLADE DISPENSER
100 Utility Knife Blades

S11-921 A
Heavy Duty

\$7.95

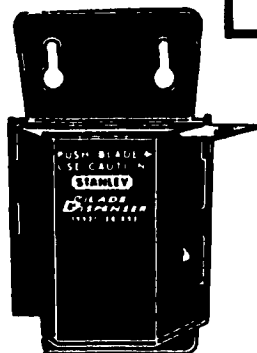

SUPREME HXD #30 OIL = 5 Gallon Pail Special =

\$28.95

1540 DIESELALL OIL
\$29.95



SCHAUER No. FC40
(#6423)

For 6 Or 12 Volt Batteries

STARTER/CHARGER

Reg. \$129.95 **\$116.95**



DOW CORNING® SILICONE
100% Silicone Sealant

\$3.95 Tube

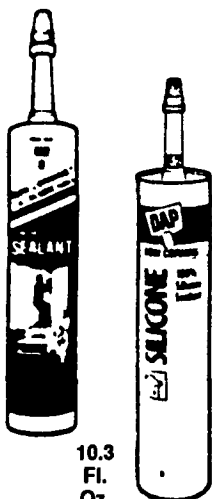

10.3 Fl. Oz.

AMES® SINCE 1774
a McDonough company

DIRT SHOVEL

#15-543

Round Point,
47" Long Handle -

\$4.95



AMERICAN TOOL

10 WR® VISE-GRIP®

\$6.95

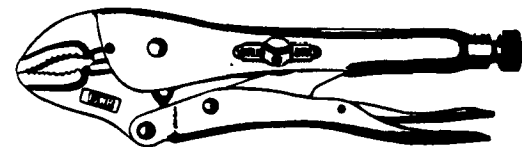

WATER PRO ENERGY-FREE LIVESTOCK FOUNTAINS

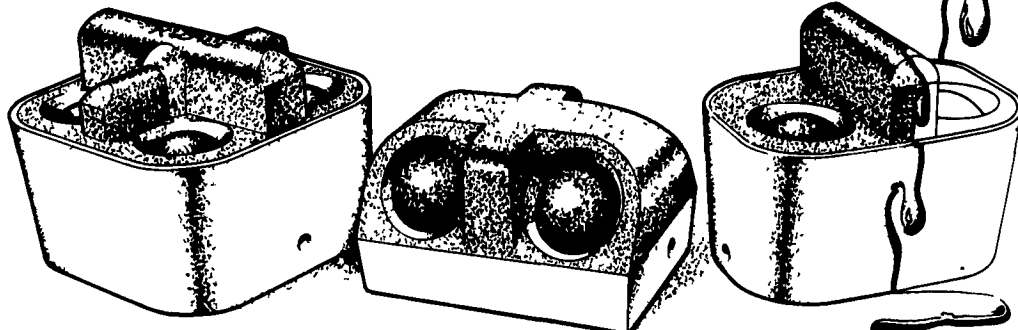

- High Impact Polyethylene
- Anti-Siphoning - All Plastic - No Float
- Polyurethane Foam

Just add water!

EXACT MASTER PROFESSIONAL LEVEL
MASON'S LEVEL - MAHOGANY

MPO-48
\$39.95



FREE REFRESHMENTS - COFFEE AND COOKIES!

