

Stockholder Capital

(Continued from Page A1)

Keystone's Board of Directors was the adoption of the Capitalization Plan, which will within five years, retire excess stock. Excess stock is considered to be the difference between 5 percent of all of a member's outstanding loan balances and 2 percent of the

aggregate of a member's outstanding loan balances. In the first phase of the stock retirement, 3,161 eligible stockholder/members in Keystone's nine branches received the financial benefits of the Plan.

Keystone Farm Credit, ACA is one of 16 ACA (Agricultural Cre-

dit Associations) in the Baltimore District which serves Pennsylvania, Delaware, Maryland, Virginia, West Virginia and the Commonwealth of Puerto Rico with agricultural financing, rural property loans and other farm-related financial services. The nationwide Farm Credit System is the leading agricultural lender in the country.

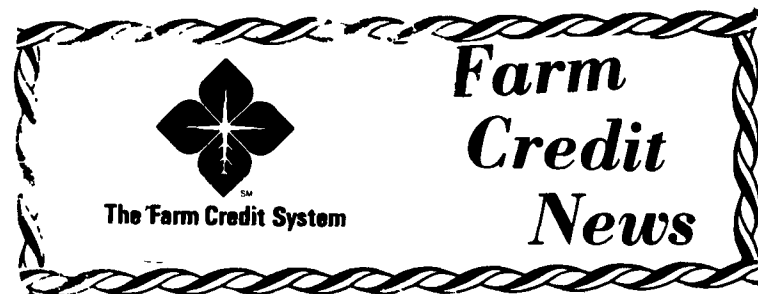

HERSHEY EQUIPMENT CO., INC. -

YOUR EXCLUSIVE



Big Dutchman®

DISTRIBUTOR

PULLET CAGES

CHICK-AIRE 3 TIER

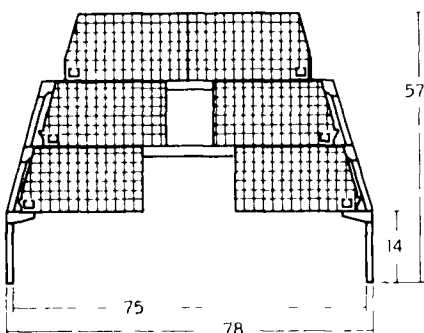

Available in 10-foot cage sections
Cage size Options:

24"x26" or 30"x26"

Available with:

- Two decks start and one deck grow
- or Three decks start

Capacities in Birds Per Running Foot of Cage Row:

Sq. Ins. Per Bird	Birds Per Foot
39	48
41	45.6
43.3	43.2

CHICK-AIRE II WITH DROPPING BOARDS

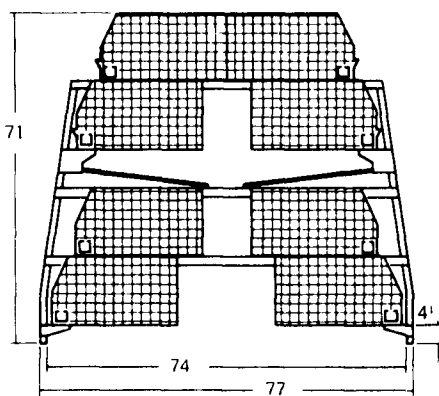

Available in 10-foot cage sections
Cage size options:

24"x26" or 30"x26"

Available with:

- Two decks start and two decks grow
- or Four deck start

Capacities in Birds Per Running Foot of Cage Row:

Sq. Ins. Per Bird	Birds Per Foot
39	64
41	60.8
43.3	57.6

BULK BINS

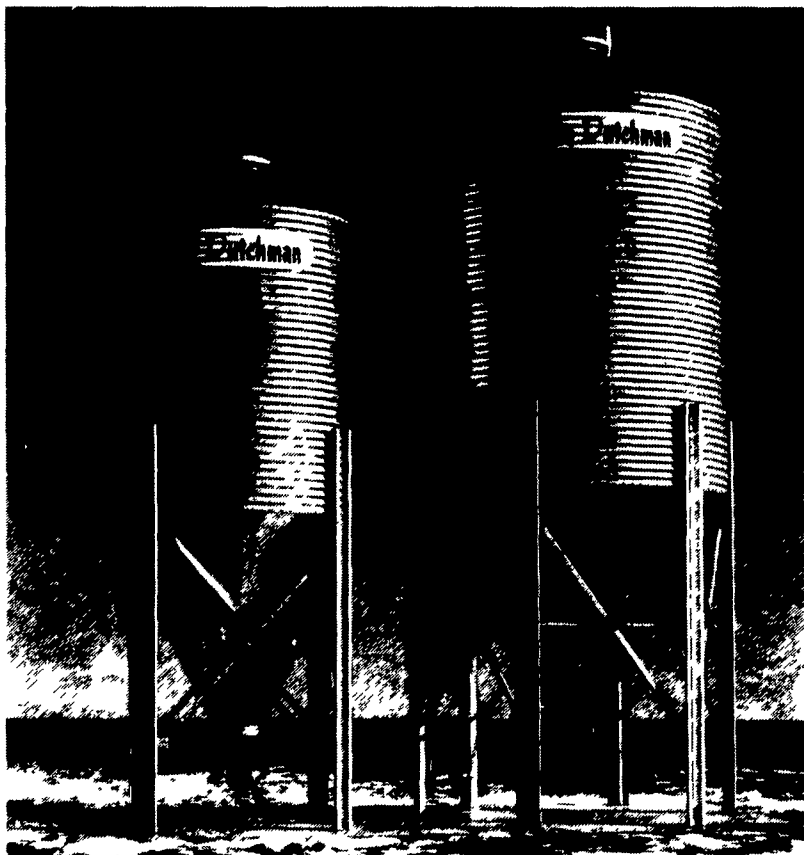

LAYER CAGES

Tri-Deck II

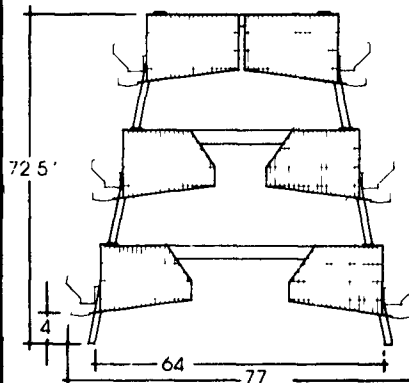

High density in the proven low profile cage design. Available in 8-foot or 10 foot cage sections. Cage size options 12' x 20', 15' x 20', 16' x 20' and 24' x 20'.

Capacities in Birds Per Running Foot of Cage Row:

Sq. Ins. Per Bird	Birds Per Foot
50	28.8
53.3	27
60	24

Profit-Tier 20

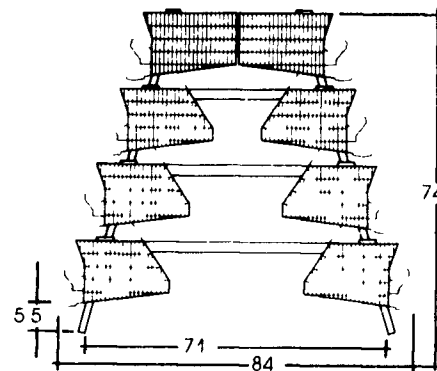

Four tiers of low profile 20 deep cages on a condensed row width for very high capacity without crowding. Available in 8 foot or 10 foot sections. Cage size options 12' x 20', 15' x 20', 16' x 20' and 24' x 20'.

Capacities in Birds Per Running Foot of Cage Row:

Sq. Ins. Per Bird	Birds Per Foot
60	32
53.3	36
48	40

CAGE WATERING SYSTEMS



- Drier manure pits and greater freedom from leaks because of the triple seal stainless steel valve seat and low pressure operation.
- Completely enclosed to promote cleanliness and sanitation.

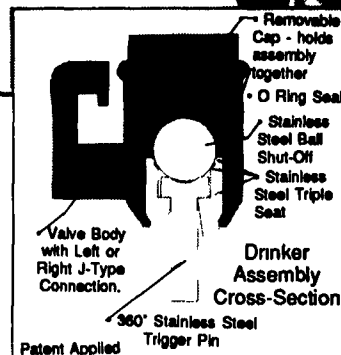

EGG COLLECTING SYSTEMS

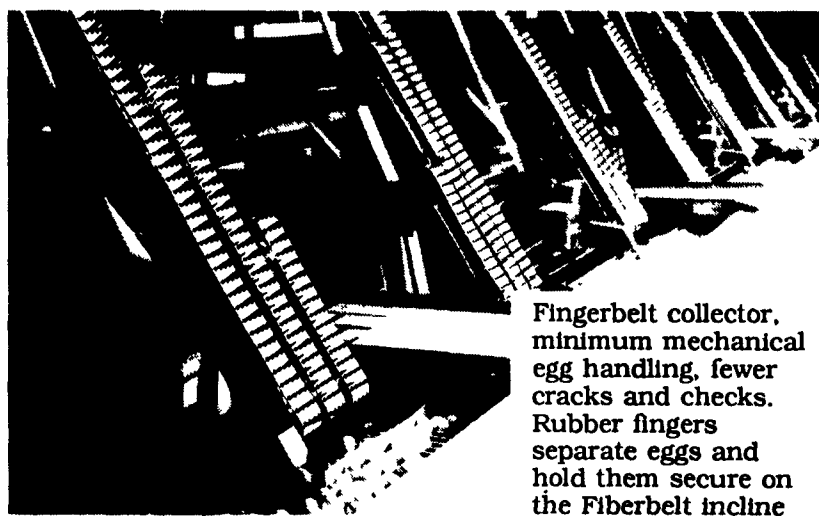

Fingerbelt collector, minimum mechanical egg handling, fewer cracks and checks. Rubber fingers separate eggs and hold them secure on the Fiberbelt incline.



HERSHEY EQUIPMENT COMPANY, INC.

SYCAMORE IND. PARK
255 PLANE TREE DRIVE
LANCASTER, PA. 17603
(717) 393-5807

Route 30 West
at the
Centerville Exit.

Designers of Quality Systems for Poultry, Swine and Grain Handling

