

FOR YOUR CONVENIENCE  
WE SELL PULLEYS, V-BELTS,  
SPROCKETS & CHAIN.

# BLUE BALL MACHINE CO., INC.

DISTRIBUTORS OF SUPPLIES & MACHINES  
FOR METAL & WOODWORKING INDUSTRIES

RTE 322 EAST PO BOX 369  
BLUE BALL, PA 17506  
717-354-4478

NEW STORE HOURS:  
MONDAY - FRIDAY 7:30-5:00  
SATURDAY: 8:00-12:00



## ▲ DELTA DAY - PARK & WORK DAY BLUE BALL MACHINE CO. INC. SEPT. 2, 1989 - 10:00 AM TILL

CELEBRATING 105 CONSECUTIVE YEARS OF SERVICE  
WITH YOU - 1105 PM - 10.5% CASH DISCOUNT -  
FREE BALLOONS & PENCILS - MERCHANDISE AT  
FLEA MARKET PRICES AND THESE DELTA  
SPECIAL PRICES. (NO CASH DISCOUNT)

ULTIMATE SAWING MACHINE  
**DELTA 10" UNSAW**  
WITH UNIFENCE™ SAW GUIDE

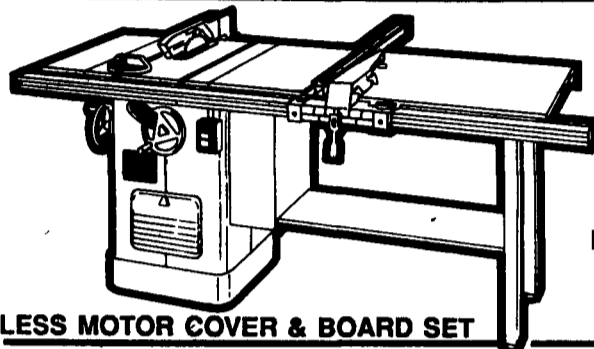

YOUR CHOICE'  
**\$1599<sup>00</sup>**  
  
Plus  
\$200.00  
MERCHANDISE  
ALLOWANCE

**DELTA**  
HEAVY DUTY  
**WOOD  
SHAPER**

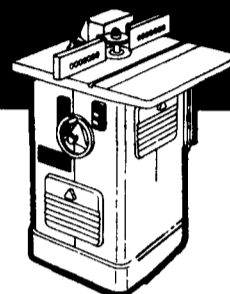

LESS MOTOR COVER & BOARD SET

**16 1/2" DRILL PRESS**

Performs an amazing variety of useful operations - drilling, plug cutting, mortising, sanding and more

**16" MOTORIZED BAND SAW**

For big capacity, heavy duty straight line sawing and curve cutting jobs - too big for other type saws to handle

**SUPER 10 MOTORIZED SAW**

Big capacity, for ripping, cross-cutting, mitering, beveling - unmatched versatility for extra jobs like dadoing and moulding.



#17-900  
**\$389<sup>00</sup>**

#28-500  
**\$409<sup>00</sup>**

#37-280  
**\$369<sup>00</sup>**

#34-740  
**\$449<sup>00</sup>**

**6" MOTORIZED JOINTER**

For all your jointing and surfacing operations including the 'extra' jobs of tapering, rabbeting, chamfering and beveling

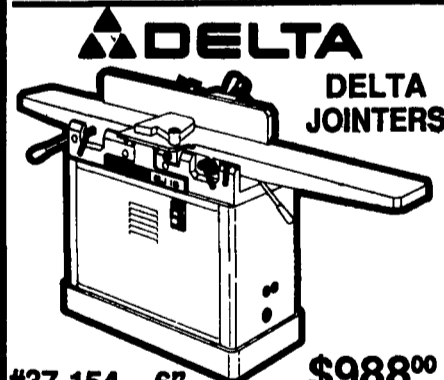

#37-154 - 6"  
#37-354 - 8"

**\$988<sup>00</sup>**  
**\$1399<sup>00</sup>**

**DELTA**  
**7" Standard  
Grinder**

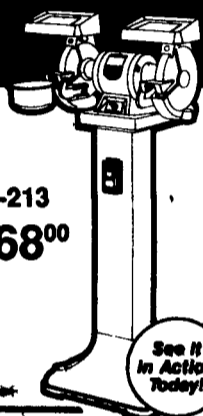

#23-213  
**\$668<sup>00</sup>**

See it  
in Action  
Today!

**DELTA 1"  
BELT SANDER**



#31-050  
**\$79<sup>00</sup>**

**DELTA 8" DRILL  
PRESS**

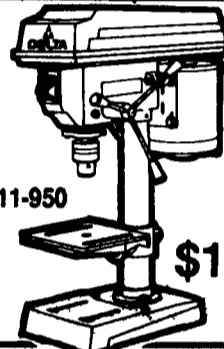

#11-950  
**\$119<sup>00</sup>**

**DELTA SANDER**

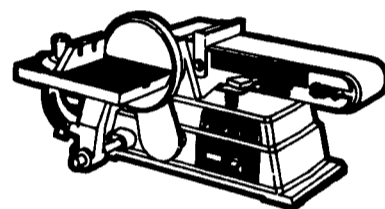

#31-460  
**\$129<sup>00</sup>**

**DELTA**  
**14" Metal-  
Wood  
Cutting  
BAND  
SAW**

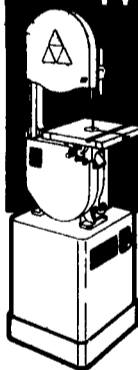

Cuts  
Any  
Sawable  
Material!

#28-283  
**\$378<sup>00</sup>**

PLUS  
MFGR'S REBATE **\$100<sup>00</sup>**

**NEW DELTA**  
**18" ELECTRONIC  
VARIABLE SPEED  
SCROLL SAW**

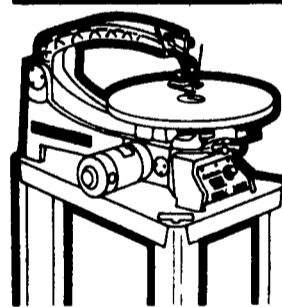

#40-601  
**\$895<sup>00</sup>**

PLUS MFGR'S REBATE  
**\$100<sup>00</sup>**

**DELTA**  
**PRODUCTION  
STOCK FEEDERS**

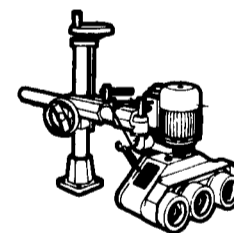

INCREASE PRODUCTION  
AND OPERATOR SAFETY

#34-985 **\$599<sup>00</sup>**  
#34-995 **\$899<sup>00</sup>**

PLUS  
MFGR'S REBATE **\$50<sup>00</sup>**  
**\$100<sup>00</sup>**

**DELTA**  
**PLATE JOINER**

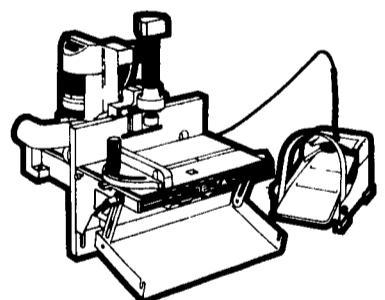

Perfectly mated pieces  
in seconds

#32-100  
**\$519<sup>00</sup>**

**DELTA**  
**CARBIDE-TIPPED  
SHAPER CUTTERS**

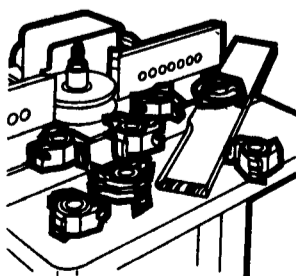

1/2 PRICE ON  
IN STOCK CUTTERS

**DELTA 10"  
MOTORIZED  
MITRE SAW**

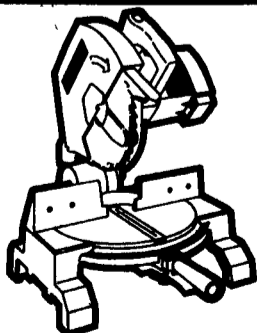

#34-080  
**\$208<sup>00</sup>**

**DELTA**  
**EDGE SANDER**

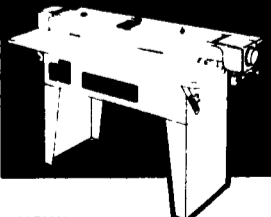

NOW!  
Straight Edge  
or Form Edge  
Sanding Capabilities  
in a Single Unit!

#31-380  
**\$1285<sup>00</sup>**

Great Versatility  
**DELTA**  
**WOOD SHAPER**

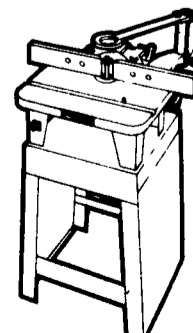

#43-122  
**\$488<sup>00</sup>**

POPULAR  
**DELTA**  
12 Abrasive Disc  
**FINISHING  
MACHINE**



Get  
Fine  
Finishes  
Fast!

#31-125  
**\$629<sup>00</sup>**

**ALL REDUCED PRICES WILL BE IN EFFECT UNTIL  
SEPTEMBER 30TH INCLUDING 10.5% CASH DISCOUNT**