

OPEN HOUSE

Thursday & Friday, April 27th & 28th
7:30 AM to 8:00 PM

JET Equipment & Tools

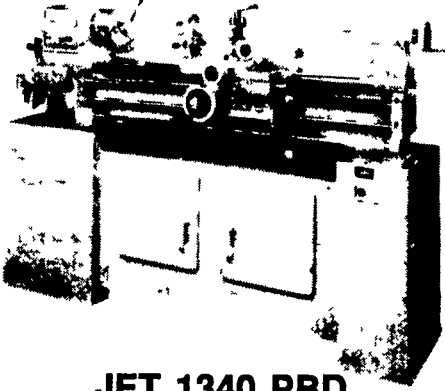

JET 1340 PBD
ENGINE LATHE

SAVE \$1,049.00

NOW **\$4,196.00**

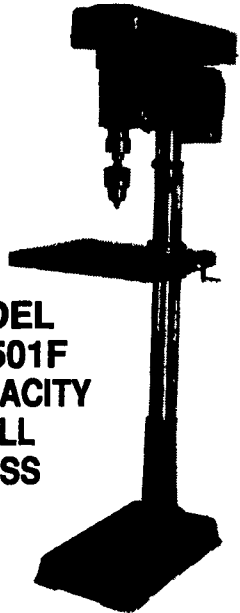

MODEL
OR2501F
1" CAPACITY
DRILL
PRESS

SAVE \$141.00
NOW

\$514.00

HORIZONTAL/
VERTICAL BANDSAW

SAVE \$229.00

NOW **\$1,896.00**



HVBS-712

8" JOINTER
SAVE \$270.00

NOW

\$812.00



JJ-8

PORTER-CABLE

PROFESSIONAL POWER TOOLS



1/2 SHEET
FINISHING
SANDER

Model No. 505



OFFSET
LAMINATE
TRIMMER

Model No. 312



Model No. 690

1 1/2 HP
ROUTER

YOUR
CHOICE
\$159.00

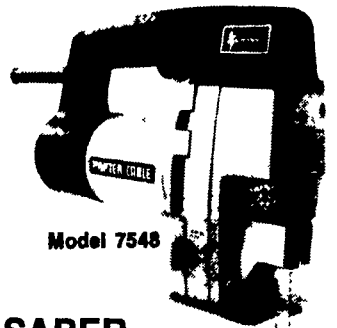

Model 7548

SABER
SAW



Model
9647

NEW TIGER CLUB
ALL-PURPOSE
SAW

WHILE QUANTITIES LAST

FOR YOUR CONVENIENCE
WE SELL PULLEYS, V-BELTS,
SPROCKETS & CHAIN, AND WE ARE
OPEN THURS. EVENINGS TIL 8:00 PM

BLUE BALL MACHINE CO., INC.

DISTRIBUTORS OF SUPPLIES & MACHINES
FOR METAL & WOODWORKING INDUSTRIES

RTE 322 EAST PO BOX 369
BLUE BALL, PA 17506

717-354-4478

STORE HOURS:

MON., TUES., WED., FRI. 7:30-5:00
THURS. 7:30-8:00 SAT. 8:00-12:00



SENCO

FASTENING SYSTEMS
20% OFF
ON SELECTED MODELS

LS PINNERS

Headless, Slight-Headed
And Medium Headed Pins
For Molding & Decorative
Trim Are Driven By
Compact LS1, LS2, LS4 &
LS5 Model Pinner.

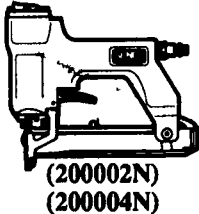

(200002N)
(200004N)

SKS POWER PLUS SERIES

Intermediate Stapler For Siding, Light
Finish Work, Door And Window Casing Assembly,
Trim And Molding. Also Cabinets, Glue Blocks
And Spring Clip Attachment In Furniture
Assembly. (300004N) (300020N)

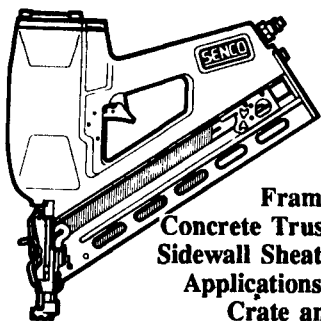
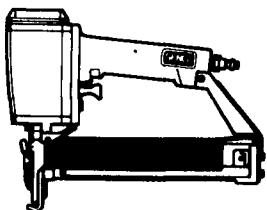

SN4
(170001N)

Full Size Nailer
For Construction
Framing, Wood - To -
Concrete Trusses, Sub-flooring,
Sidewall Sheathing & Roof Deck
Applications. Also For Pallet,
Crate and Box Assembly.

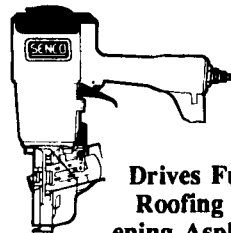

SCN200R
COIL
NAILER
(27001N)

Drives Full Round-Head
Roofing Nails For Fast-
ening Asphalt And Fiber-
glass Shingles, High Load Capacity
Of 120 Nails Minimum Production
Interruption.

CORDLESS DRIVER-DRILL KIT

2 Speed,
Variable
Speed,
Reversible



Model
60930W

SAVE \$99.00

NOW **\$149.00**

CORDLESS SCREWDRIVER KIT

Model
6094DW

SAVE \$94.00

NOW **\$159.00**



Model
6012H0W

NOW **\$139.00**

INTRODUCING THE ALL NEW

DELUXE SAWBUCK FRAME AND TRIM SAW

SAVE \$203.00

NOW ONLY
\$539.00

LEG KIT OPTIONAL

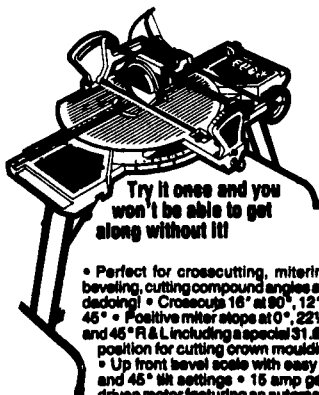

Try it once and you
won't be able to get
along without it!

• Perfect for crosscutting, mitering,
beveling, cutting compound angles and
dedding! • Crosscuts 16" at 90°, 12" at
45° • Positive miter stops at 0°, 22 1/2°
and 45° R & L including a special 31.82°
position for cutting crown moulding
• Up front bevel scale with easy 0°
and 45° tilt settings • 15 amp gear
driven motor featuring an automatic
electronic blade brake • Use it flat,
prop it on sawhorses or on accessory legs
• Single knob control for table release,
movement and locking

WE'RE STAYING OPEN TWO DAYS 7:30 AM to 8:00 PM
THURSDAY & FRIDAY, APRIL 27th & 28th JUST TO
SAY THANK YOU FOR YOUR PATRONAGE, GIVE
AWAY SOME DOOR PRIZES, HAVE YOU MEET WITH
REPRESENTATIVES FROM JET, MAKITA, SENCO &
PORTER-CABLE AND MAYBE SELL YOU THE TOOLS
YOU'VE BEEN LOOKING FOR AT SALE PRICES.



FREE COFFEE & DONUTS
FOR YOU EARLY RISERS