

Patz

A TRUE FULL LINE MANURE & FEED HANDLING MANUFACTURER

Stop By And See Us At The PA FARM SHOW

Booth #550-552

Some Of The Following Equipment Will Be On Display:

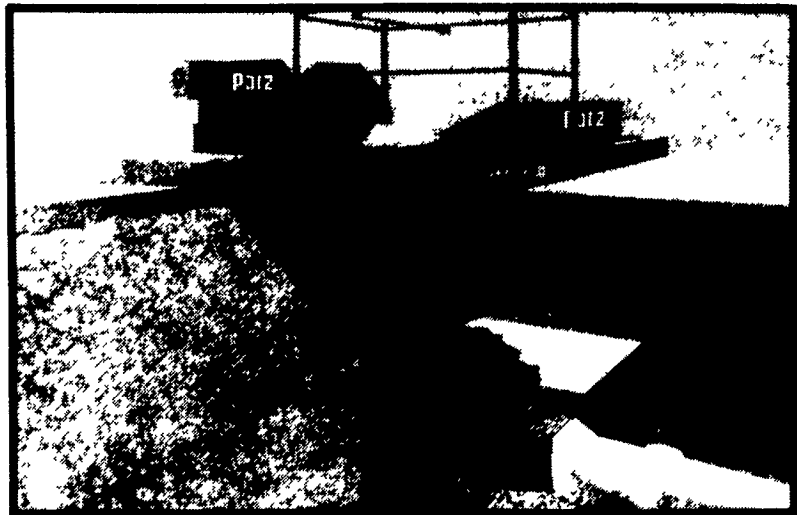

Model 100 Slurry Pump

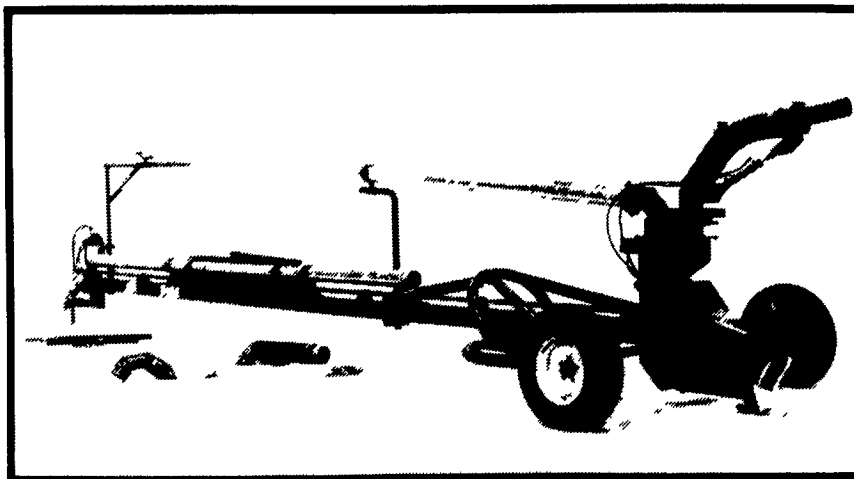

Model 477 Lagoon Pump

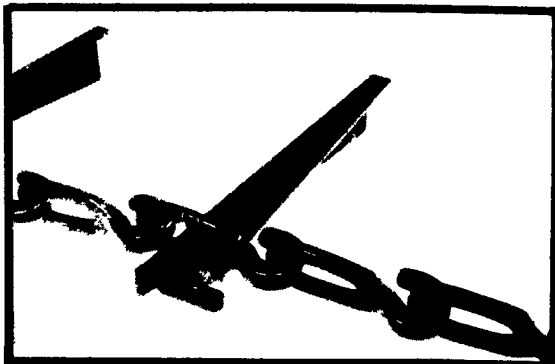

Patz Chain

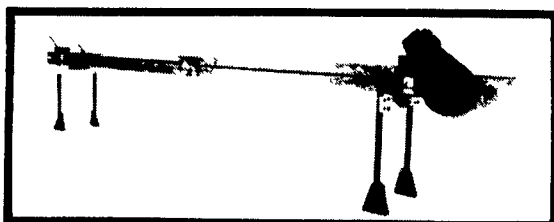

Model 8612 Belt Conveyor

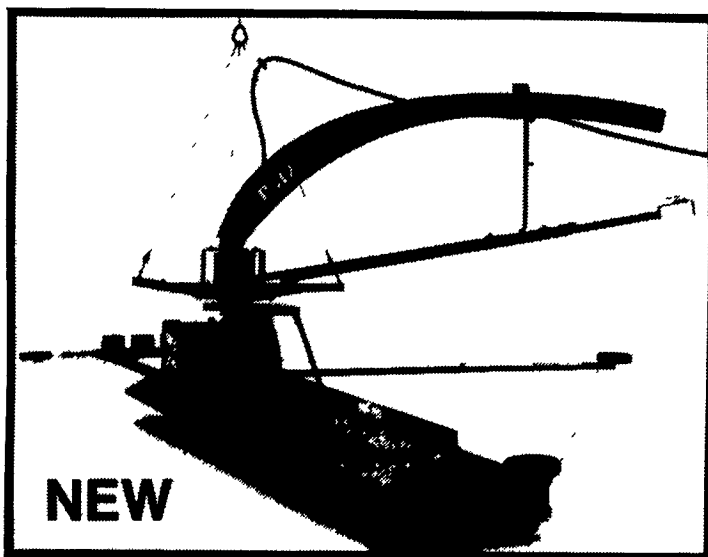

Model 8800 & 8810 Silo Unloaders
Dual Auger Surface Drive &
Dual Auger Center Drive

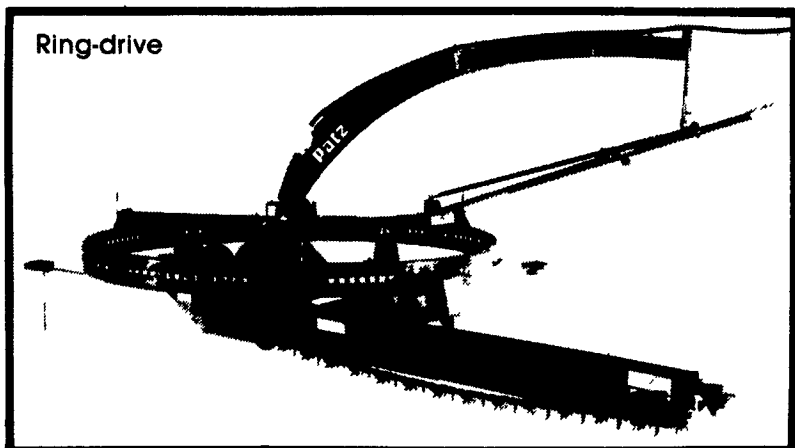

Ring-Drive Silo Unloader



Ring-Drive or Surface Drive
Feeding Systems

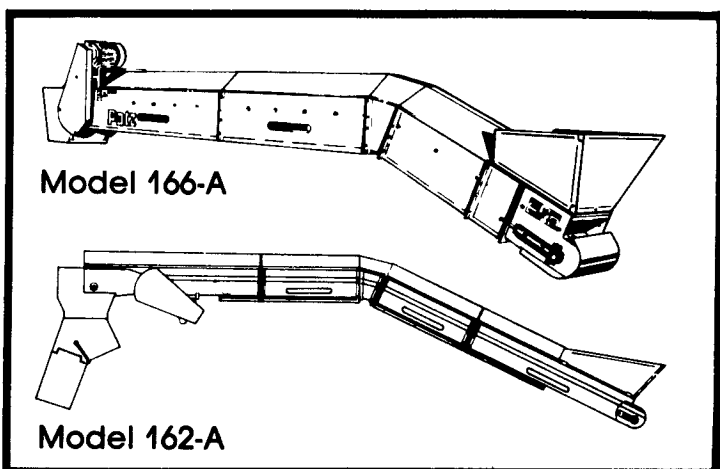

Model 166-A

Model 162-A

Conveyors...Large Capacity...Fast Delivery

Good Value Beats Good Price

When you buy equipment, look for good value. Value is different from price. Price involves only the payment at purchase. Value includes the extra benefits you receive during the years you use the Patz equipment.

Patz value includes high quality, reliability, long service life, dealer service and parts inventory to keep you operating.

When you need equipment, get the extra value from Patz.

SEE YOUR NEAREST PATZ DEALER

ALEXANDRIA
MAX ISENBERG
814-669-4027

BELLEFONTE
LUCAS BARN EQ.
814-383-2808

ELLIOTTSBURG
CARL R. BAER
717-582-2848

LEBANON
AUTOMATIC FARM
SYSTEMS
717-274-5333

QUARRYVILLE
UNICORN FARM
SERVICE
James E. Landis
717-786-4158

KENNEDYVILLE, MD
PINDER SERVICE CO.
301-348-5263

POUND, WI
PATZ SALES, INC.
414-897-2251

BALLY
LONGACRE
ELECTRIC
215-845-2261

BELLEVILLE
MILLER-LAKE Inc.
717-935-2335

HAMBURG
SHARTLESBURG
FARM SERVICE
215-488-1025

MIFFLINTOWN
ZUG FARM &
DAIRY EQUIPMENT
717-463-2606

SOMERSET
GROVE EQUIP. SALES
Clifford Knepper
814-445-6306

LINEBOR, MD
TRI-CO. DAIRY
EQUIPMENT
301-374-6616

DISTRICT MANAGERS
Dennis Skibo
717-664-2333
Jim Bilski
814-944-0117

CAMP HILL
JOHN JONES
717-737-5737

KINGSLEY
POWERS EQUIPMENT
717-434-2082

MILTON
NORTH CENTRAL
AG AUTOMATION
(Formerly L&W Ag)
717-437-2031

HAGERSTOWN, MD
TRI-STATE
FARM AUTOMATION
301-790-3698

WHITEFORD, MD
ENDFIELD EQUIP.
301-838-0480