

# E.M. HERR COMPANY WELCOMES YOU TO THE 1988 AG PROGRESS DAYS

AUGUST 16, 17 & 18

LOCATED: West 5th Street

Register To Win:  
Golf 12 Qt. Cooker  
Or  
24 Pc. 1/2" Drive  
Socket Set



**GSI GRAIN BINS AND ACCESSORIES**

Factory Warehouse Prices

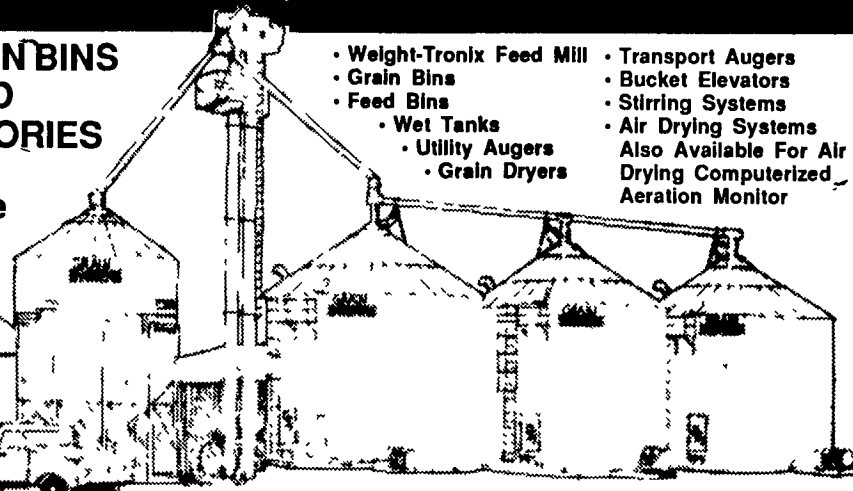

- Weight-Tronix Feed Mill
- Grain Bins
- Feed Bins
- Wet Tanks
- Utility Augers
- Grain Dryers
- Transport Augers
- Bucket Elevators
- Stirring Systems
- Air Drying Systems
- Also Available For Air Drying Computerized Aeration Monitor

Galvanized Bucket Elevator

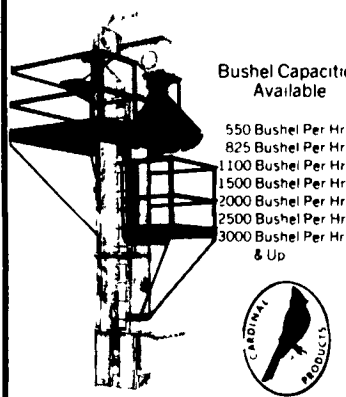

Bushel Capacities Available

- 550 Bushel Per Hr
- 825 Bushel Per Hr
- 1100 Bushel Per Hr
- 1500 Bushel Per Hr
- 2000 Bushel Per Hr
- 2500 Bushel Per Hr
- 3000 Bushel Per Hr & Up



**B & W GRAIN AERATOR**

**\$99.99**

**ff AUTO GRAIN DRYERS**



**FEED LOT PANELS**

- 1/2" Galv. Wire, 16' Length
- 34" High Hog Panel
- SALE PRICE **\$14.99** Ea.
- 52" High Cattle Panel
- SALE PRICE **\$16.99** Ea.

**Hobby High Pressure Kendall K.E.W. Washer**



For Only **\$369.99**  
Up To 1,000 lb. P.S.I.  
Includes Automatic Bypass Handle  
U.L. Approved

Flex-Auger Systems, PVC Tubing, 2", 3", 4" & 5" Diameter Systems

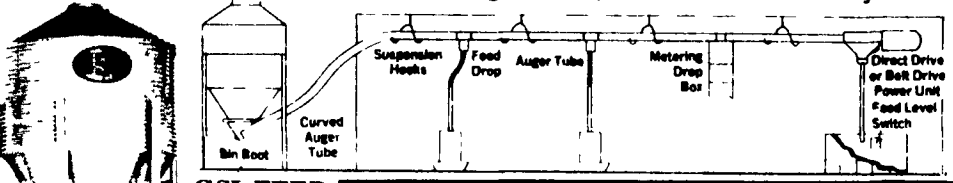

**GSI FEED BINS**  
From 2 1/2 Ton To 150 Ton

**MODERN AG STAINLESS STEEL FEEDERS**  
100% Welded Construction

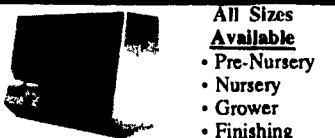

- All Sizes Available
- Pre-Nursery
  - Nursery
  - Grower
  - Finishing

**TAFCO Ventilation Fans**

- 12".....\$79.95
- 16".....\$115.95
- 20".....\$139.95
- 24".....\$189.95
- Ranco Therm.....\$23.00

**HEAVY DUTY FARROWING CRATE**  
European Style

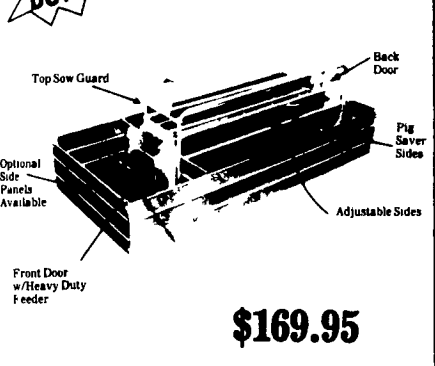

**\$169.95**

**Sukup Grain Handlers**

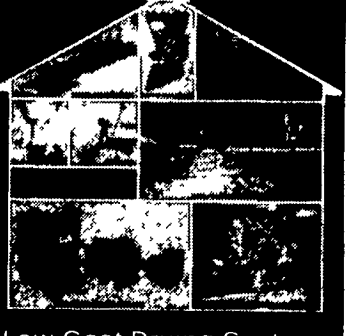

Low Cost Drying Systems

**ADS GRAIN-AIRE®**

**NEW LOW COST AERATION SYSTEM**  
Ideal For All Types Of Flat Storage Facilities  
The Grain-Aire™ protective screen maximizes air flow. This durable material features 30 percent open area to allow for unrestricted airflow. This woven polypropylene screen prevents restriction of the perforations and maximizes airflow by providing 360° aeration



**WEIGH-TRONIX**

**FEED MIXER THE BEST IN THE INDUSTRY ON DISPLAY**

- FARMMASTER GATES**  
Hot Dip Galvanized
- 6'.....\$27.99
  - 8'.....\$34.99
  - 10'.....\$37.99
  - 12'.....\$42.99
  - 14'.....\$49.99
  - 16'.....\$54.99

**HYDRAULIC FLUID**  
Hydraulic Fluid  
**\$18.99** 5 Gal. Pail

**SILO COVERS**

|         |         |
|---------|---------|
| 14'x14' | \$5.19  |
| 16'x16' | \$6.59  |
| 18'x18' | \$8.29  |
| 20'x20' | \$9.99  |
| 24'x24' | \$14.59 |

**PLASTIC SHEETING**  
Heavy 6 Mil. Thick Blade Polyethylene 100 Ft. Rolls

|          |         |
|----------|---------|
| 28" Wide | \$79.99 |
| 32" Wide | \$89.99 |

**BALING TWINE**  
BALING TWINE CLOVER  
• 1-9.....\$19.99 Per Bale  
• 10 Or More.....\$18.59 Per Bale

**BRAVE VERTICAL-HORIZONTAL LOG SPLITTER**



20 Tons of Splitting Force  
BRAVE-DOES IT AGAIN  
"The Payoff Is Performance"

**TRUCKLOAD SALE**

Heavy Duty 3 Gauge Wire  
8 Yr. Warranty



PANEL NOT INCLUDED

**DELPHI WOVEN WIRE FLOORING**  
Sizes: 4x8, 5x7  
Also Custom Sizes Available  
Available: Tenderfoot & Plastic Flooring

**HIGH TENSILE FENCING SUPPLIES**

**High-Tensile Wire**  
12 1/2 gauge, Class 3 Galv.  
4,000' per coil, Made in U.S.A.  
180,000 P.S.I. **\$59.99**

**FW2-3 12 1/2 Gauge Crmping Sleeve**  
**\$14.99** Pack of 100

**Strainer Handle**  
**\$4.79**

**In-Line Strainer**  
**\$2.49**

**4" Tube Insulator**  
**\$10.89** Pack of 200

**Wraparound Insulator**  
**\$10.89** Pack of 10

**Type "W" Insulator**  
**.39** ca.

**Tension Spring**  
**\$4.19**

**PERMECTRIN II**  
1 Quart  
Reg. \$38.99 **NOW \$33.88**

**EARLY ORDER SALE SPEEDY CORN CRIBS**  
• Easy To Erect  
• Rods Instead Of Bolts On Wire Mesh  
**\$999.00**  
Place Your Order **NOW And SAVE**

**PREAGRO GRAIN TESTER**



Reg. \$279.99  
**SHOW PRICE - ONLY \$199.99**

**YOUR FARM SUPPLY HEADQUARTERS**  
EM HERR EQUIPMENT INC. EM HERR FARM & HOME CENTER

- Grain Storage Auger & Drying Equipment  
Hog Equipment, Buildings & Supplies  
Feed Tanks & Flex Auger Systems  
Bucket Elevators & Trough Conveyors  
Top Dry, Air Dry, And In-Bin Drying Systems  
Ventilation & Cooling Systems  
Poultry Parts & Supplies  
Parts, Service & Installation  
LP Gas Heaters, Heatpads & Accessories  
Controls, Moisture Tester & Supplies  
Portable Batch & Contin. Flo Dryers  
Electric Motors & Pulleys  
Complete Turnkey Feed Mills
- Farm & Home Supplies  
Plumbing & Electric  
Fencing & Supplies  
Lawn & Garden  
Sprayer Parts & Accessories  
Feed, Salts & Pet Supplies  
Clothing & Footwear  
Hand & Power Tools  
Animal Health Products  
Automotive  
Paint & Accessories  
Welders & Supplies  
Rentals

**Dayton**

**Model 3C615**  
Fan: 36" blade dia galvanized frame and blade  
Motor: 1/2 HP, 1725 RPM, 115/230V TENV enclosure, ball bearing, split phase, automatic thermal protection, rigid mounting base.

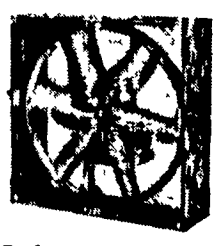

**BELT DRIVE FANS**  
36" with 1/2 H.P. Motor  
Mfg. List \$309.00  
**SALE \$199.99**  
Shutters Available

| MODEL NO. | CERTIFIED CFM LICENSED BY AMCA (*) |          |          |           |          |          |          | FAN RPM | MAX. FAN BHP(I) WT. | SHPG. WT. |
|-----------|------------------------------------|----------|----------|-----------|----------|----------|----------|---------|---------------------|-----------|
|           | 0 0" SP                            | 0 05" SP | 0 10" SP | 0 125" SP | 0 15" SP | 0 20" SP | 0 25" SP |         |                     |           |
| 3C615     | 11,300                             | 10,750   | 10,200   | 9900      | 9500     | 8750     | 7750     | 510     | 0.63                | 108.0     |

Your One Stop Hardware - Farm Supply Store

# EMHERR FARM & HOME

We Accept

14 Herrville Rd. Willow St., Pa. 17584  
Ph: 717-464-3321

Toll Free in PA 800-732-0053