

FORD NEW HOLLAND OFFERS THE BEST EQUIPMENT AT THE LOWEST POSSIBLE INTEREST RATE!

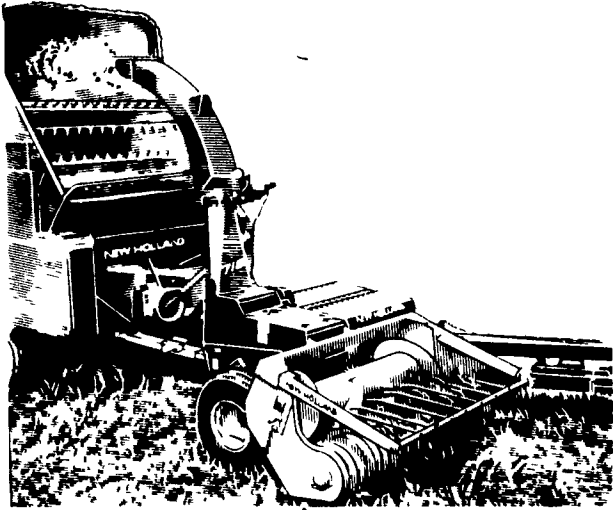

718 FORAGE HARVTER

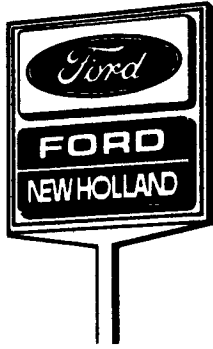

TEDDERS

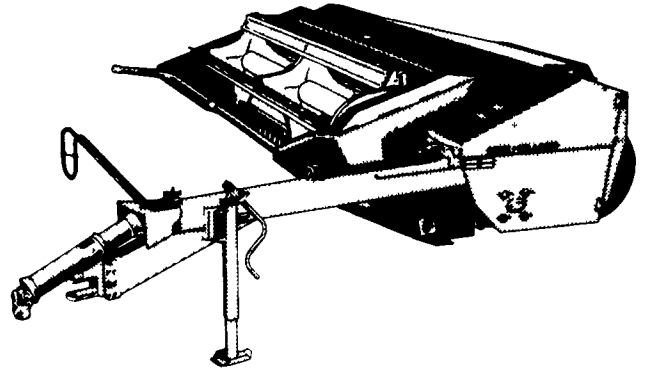
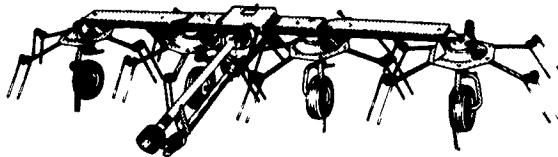

MOWER CONDITIONERS

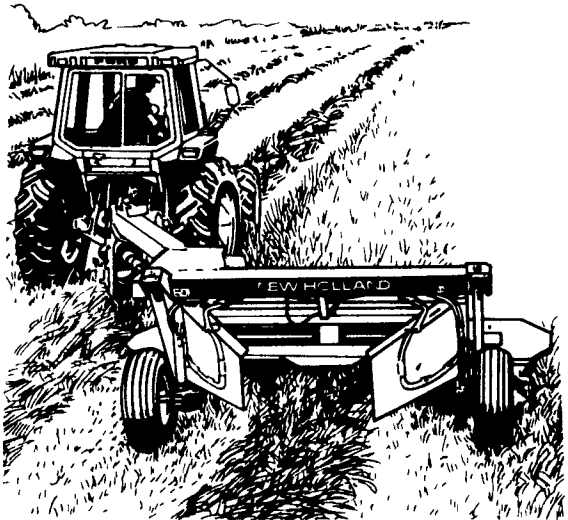

DISC MOWER CONDITIONER

Everything you want in farm equipment ...and less.

0.0% A.P.R.
FOR 12 MONTHS.

We've got new:
• New Holland equipment

All at the low finance rate of 0.0%. Need longer terms? Ask us about our other attractive finance plans. Offer good until June 30, 1988. Available exclusively through Ford Credit for qualified buyers.

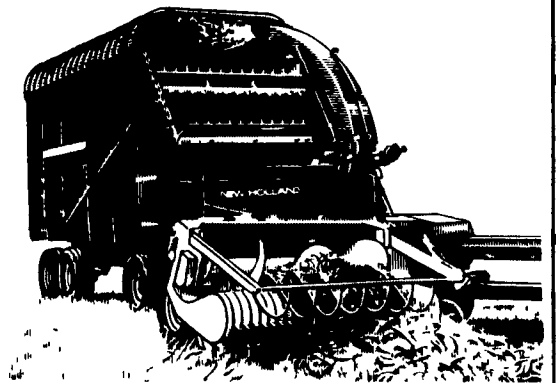

790 & 900 FORAGE HARVESTERS



40 FORAGE BLOWER

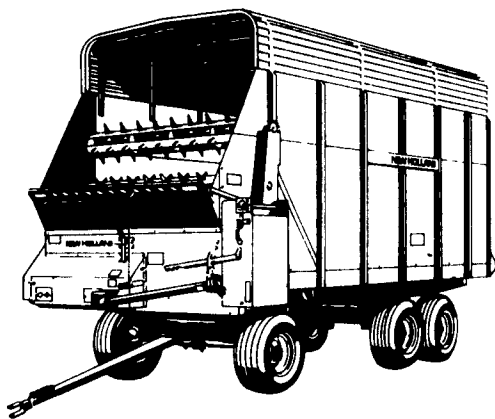

716 FORAGE BOX

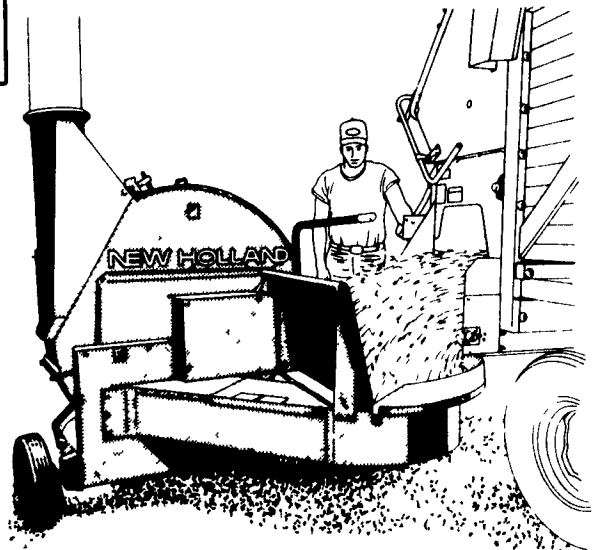

28 FORAGE BLOWER

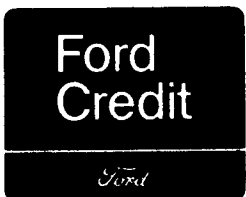

ADDITIONAL OPTIONS INCLUDE:
LOW A.P.R. FINANCING:
 5.9% FOR 24 MONTHS
 7.9% FOR 36 MONTHS
 8.9% FOR 48 MONTHS
 9.9% FOR 60 MONTHS
 - OR -
DISCOUNTS FOR CASH PURCHASES

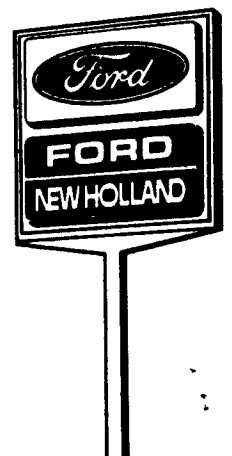

SEE YOUR NEAREST FORD NEW HOLLAND DEALER FOR COMPLETE DETAILS