

CENTRAL TRACTOR FARM & FAMILY CENTER

The Surprising Store!

FIX-UP SPECIALS





1999
Reg 209.99 / SAVE 10.00
19741-243
30" De-thatcher Sweeper
• 30 inch de thatching and sweeping width
• Fully adjustable front mount de thatcher - can be raised to transport position for sweeper only operation
• 7 1/2 cubic foot easy-dump, collapsible hopper



31999
9 Digger / 20324-157
33999 12 Digger 20331-157
Post Hole Digger
• Fits category 1 or 2 tractor
• 3 year gear box guarantee
• Four position boom allows adjustments to adapt to most 3 point tractors
• Hard-surfaced digger blades

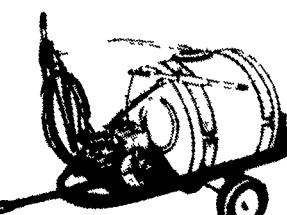

999
5 Gallons
Reg 11.99 / SAVE 2.00
14139-272
Roof Coating
• Fibered black coating emulsion re saturates old felt



39999
16500-100 / 25 Gallon
Lawn and Garden Mini Sprayer
• Hand gun and 25 ft hose
• High pressure roller pump
• Boom covers 7 with 2 flood jet nozzles
55 Gallon Lawn and Garden Sprayer 20270-100 **NOW 519.99**

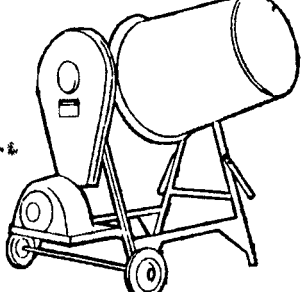

18999
27917-308
3.5 Cu. Ft. Cement Mixer
39999
Reg 419.99
26020-308
5.5 Cu. Ft. Heavy Duty Cement Mixer



89999
#3612 25 Side Discharge
#3612 26 Rear Discharge
36" Dynamark® Riding Mower
30 Trailer Type Lawn Sweeper 22499-258 **NOW 119.99**
Optional Bagger 5708-08 **NOW 179.99**



349
Reg 4.49 / SAVE 1.00
1 Gallon 14011-272
1149 5 Gallons 14012-272
Fiberglass Roof Patch Cement
• Can be applied to either wet or dry roof surface



2199
Reg 24.99 / SAVE 3.00
2 gallon / 18049-114
2599 3 gallon / 18005-114
Reg 28.99 / SAVE 3.00
Polyethylene Sprayer
• Pump barrels and caps are made of polypropylene
• Ideal for use with materials that are corrosive to galvanized or stainless steel sprayers



9999
29721-300
Structo® 24,000 BTU Cartgrill
• 225 sq. in. primary cooking area



149999
18 Horse Power Dynamark® 45" Ground Engaging Tractor Mower
• Briggs & Stratton 1/C series engine with 2 year warranty
• Model 4518-05
Optional Bagger **NOW 179.99**
5708-08



1199
5 Gallons
Reg 13.99 / SAVE 2.00
14269-272
Black Roof/Foundation Coating
• All season formula
• Brush or trowel grade
• Asphalt base



28999
18121-115
Lincoln 225 Amp AC/DC Arc Welder
• Wheels not included
5 lbs - WELDING ROD
AWS-E6013 1/4" 18310-115 **SALE 2.99**
Reg 3.49
AWS-E6011 1/4" 18327-115 **SALE 2.99**
Reg 3.49
WS-E6011 1/4" 18334-115 **SALE 3.49**
Reg 3.99
AWS-E6013 7/32" 18341-115 **SALE 3.49**
Reg 3.99

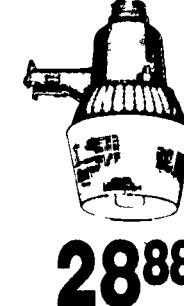

2888
Reg 31.99 / SAVE 3.11
28200-311
175 Watt Mercury Vapor Yard Light



1699
12656-040
Swivel Jack
• Assembly may be turned 90° horizontal or vertical
• Locking handle holds device in any position
Tubular Connection Swivel Jack 12665-040
Reg 29.99 **SALE 24.99**



9999
Dynamark® 20" Rotary Mower
• Model 2035-06
• IN CARTON ONLY

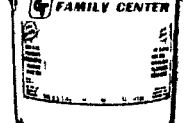

2999
5 Gallons
13974-272
Aluminum Roof Coating



21999
Reg 249.99 / SAVE 30.00
96981-035
Utility Trailer
• 4 x 8 Bed
• Meets or exceeds all DOT regulations
• Folds for easy storage

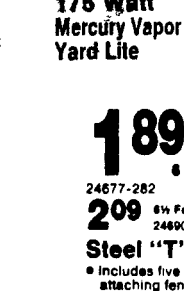

189 6 Foot
209 8 1/2 Foot
24677-282
24690-282
Steel "T" Post
• Includes five clips for attaching fence to post
7 Foot / 25439-282 / **NOW 2.29**



32999
Reg 349.99 / SAVE 20.00
25402-293
High Pressure 3/4 HP Washer
• 500 600 psi 2 gpm pump
• 5 way valve
1 1/2 Hp Industrial H.P. Washer 25468-293 **NOW 549.99**



2499 5 Gallons
Red 9462-060 / White 9484-060
Barn & Fence Latex Paint

3999 5 Gallons
Red 9478-060 / White 9480-060
Barn & Fence Oil Paint
• Excellent durability
• Not poisonous to animals
Exterior Oil Latex Primer 95357-060
Reg 14.99 / **SALE 12.99** gallon



9995
Reg 119.95 / SAVE 20.00
13478-063
Category 1 Cultivator
• Row width adjustment
• Includes six C lines with reversible points
Replacement Shovel for 13478-063 12773-001 **NOW 3.39**



299 1/4" x 50'
Reg 3.99 / SAVE 1.00
19253-143
Vinyl Hose
• 2 ply green hose
• Brass couplings



5 Panel Steel Gates
48" high gates with 22 gauge galvanized steel panels. Gates are 4" shorter than listed to compensate for hinges. Screw hooks and hinges included.

10' Gate 17686-253	31.99	14' Gate 17676-253	41.99
12' Gate 17687-253	35.99	16' Gate 17677-253	44.99



19999
Reg 219.99 / SAVE 20.00
20294-100
Pick-Up Truck Tank
• 475 Gallon
• Made of durable lightweight polyethylene



49 48" long
17895-130
Steel Rod Electric Fence Posts
• Made of 11/32" steel



1299 1/2" x 75'
Reg 16.99 / SAVE 3.00
19254-143
Rubber/Vinyl Hose
• Strength and durability of rubber plus flexibility of vinyl
• Reinforced with nylon truck tire cord
• Solid brass couplings

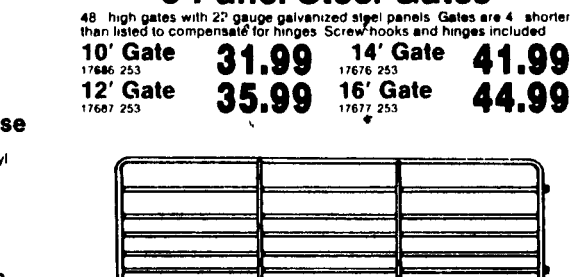

7 BAR TUBE GATE
1 1/4" 7 Bar Round Tube Gate

4' Gate 17863-253	34.99	6' Gate 18187-253	37.99
8' Gate 17871-253	39.99	10' Gate 17824-253	42.99
12' Gate 17831-253	46.99	14' Gate 17849-253	51.99
16' Gate 17856-253	56.99	18' Gate 17848-253	64.99



47999 4 Foot
23648-280
3 Point Rotary Cutter
• Free swinging 3/4" x 3 suction blades
• Cutting height 2 to 12
• Rated for tractors to 45 hp
5' Rotary Mower 23557-290 **NOW 519.99**
6' Rotary Mower 23655-280 **NOW 779.99**

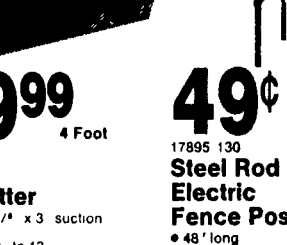

5999 100 Gallon
500 50 Gallon
5499 50 Gallon
Sediment Replacement Filter 49 99-5 00 rebate = 44 99 net
Central Tractor's PRICE
Less Rebate from Mfr
Your Final Net Cost
22602-176
22718-176



8799 38 Fence / 24678-282
939-611
9799 47 Fence 1047-611
24681-282
Field Fence
38 Field Fence / 939-612 24706-282 **NOW 67.99**
47 Field Fence / 1047-612 24707-282 **NOW 77.99**



15999 3 HP
16812-100
Gas Powered Centrifugal Pump
• Self priming pump
• 140 gpm @ 30 psi 2 NPT inlet & discharge
• Lightweight & portable
5 Hp Centrifugal Pump 18972-100
Reg 209.99 **NOW 199.99**

"EVERY DAY LOWER PRICES"
CENTRAL TRACTOR FARM & FAMILY CENTER



We reserve the right to limit quantities. Sale ends on above date. Not Responsible For Printing Errors.

THESE PRICES WILL BE HONORED ONLY AT THE LANCASTER, PA STORE
SALE STARTS NOW THRU SUN., MAY 1, 1988
LANCASTER
1570 Manheim Pike, Ph. 717/569-0111
8:30 a.m. to 5:30 p.m. Mon. thru Fri.
8:30 a.m. to 5 p.m. Sat., Sun. 12:00 p.m. to 5:00 p.m.

Some Items Are At A Reduced Price. If An Item Is Not Stated To Be Reduced Or A Special, It Is At Our Everyday Regular Low Price. Regular Prices May Vary By Store Location.