

It's Here Now... A Big, Discount PRICE-CUTTING SUPER SAVER SALE On State-Of-The-Art Quality Gehl All Hydrostatic SKID STEER LOADERS..... UP TO 40% OFF



Haul On Your Pickup Truck

Gehl 3310

• New Gehl Model 3310, 20 HP w/5.70x15 Tires And 48" Wide Bucket, SN#1295

One Only List Price \$12,141

DISCOUNT SALE PRICE ONLY

\$6,840

SELF-LEVELING SKID LOADER

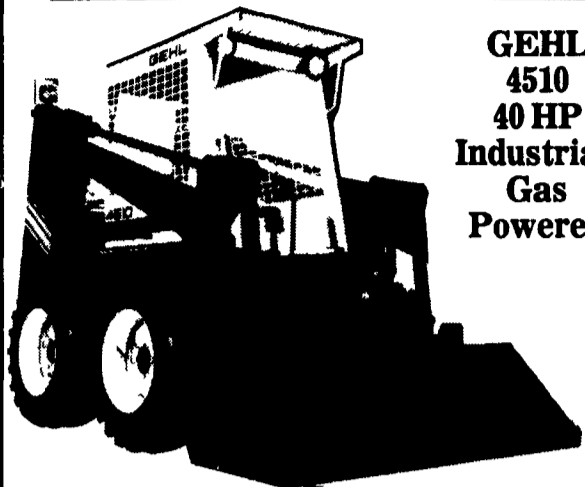

GEHL 4510
40 HP
Industrial, Gas Powered

← 65" Wide →
w/65" Bucket, 10.00x16.5 Tires
List Price \$17,000 Plus
DISCOUNT SALE PRICE... \$11,826

Just Arrived NEW GEHL 3410 DIESEL SKID LOADER

w/A New 3 Cylinder Diesel Engine **\$9,395 Come & See!**



Gehl 6620

← 72" Wide →
Operating Capacity Of 2,050 Lbs.

• New Gehl Model 6620, 60 HP w/12.00x16.5 Tires And Hi-Capacity 72" Bucket, Standard Equipped w/Front Aux. Hydraulics & Working Lights

List Price \$28,315

DISCOUNT SALE PRICE **\$18,365**

IH MODEL 225 9 FT. SELF-PROPELLED MOWER CONDITIONER

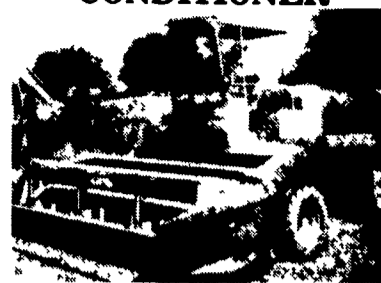

\$3,995

CASE 730 GAS COMFORT KING TRACTOR



Dual Hyd. Outlets, 540 Live PTO #8283099

\$3,650

BAKER-YORK 4,000 LB. INDUSTRIAL FORKLIFT



Lift Height: Approx. 8 Ft.
Ideal For Indoor-Outdoor Uses

ONLY **\$6,800**

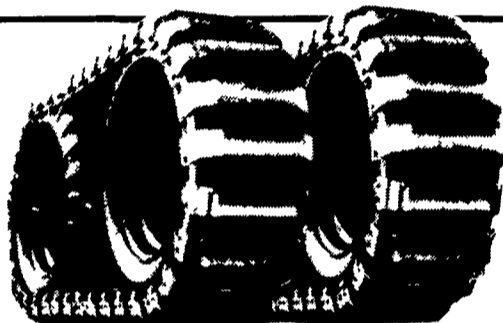

THE SURE-FOOTED TIRE CRAWLER TRACKS



LOEGERING MFG. INC.
"Best of Both"
The Soft Ride Of Rubber Plus The Durability Of Steel

See Us For All Your Needs
PLACE YOUR ORDER NOW!



BALER TWINE IN STOCK

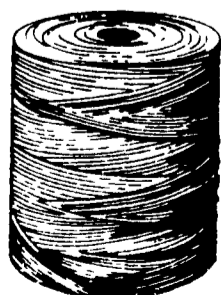

SAVE! SAVE \$\$\$ NOW!

• Good Quality Clover Baler Twine
• No. 1 Quality Sisal Twine - 9,000 Ft., 10,000 Ft.

CATEGORY I 3 POINT LIFT CARRIER ONLY

\$45.00
In Stock

- Angle iron construction
- Lower link pins included
- Attaches to 3 pt. hitch of Category 1 tractors

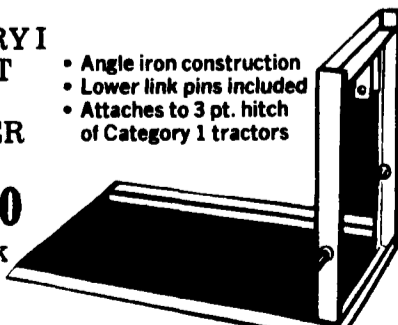

MODELS ROB48 ROB54 ROB66 ROB72 ROB84

BLADE, SCARIFIER BOX BLADE
A pull of the trip lever locates the desired position.

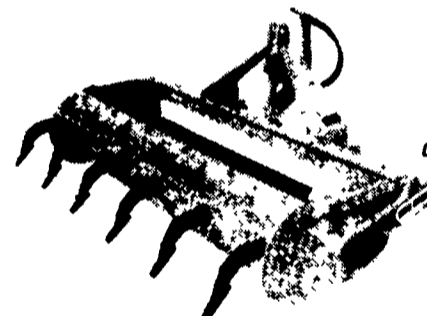

Roll Over Box Blade with optional Hydraulic Trip Lever Kit for larger tractors or tractors with cabs.

FEATURES

- 2 piece construction
- Convenient locking rod for shanks
- Shanks preset to 30° entry position
- High carbon steel reversible cutting edges
- Heavy duty "A" frame
- Greasable bearings



The Roll-Over Box Blade will drag a load or level a work site to grade

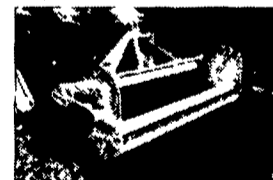

To rip, rotate the Roll-Over to the scarifying position Rigid shanks offer penetration in hard or compacted soil with minimal drag



Simply trip the lever and reverse the blade for backfilling

SPECIFICATIONS

| MODEL | ROB 48 | ROB 54 | ROB 66 | ROB 72 | ROB 84 |
|----------------------|--------|--------|-----------|-----------|-----------|
| Box height | 16 | 16 | 16 | 16 | 16 |
| Width | 48 | 54 | 66 | 72 | 84 |
| No. of shanks | 5 | 5 | 6 | 7 | 8 |
| Hitch | Cat 1 | Cat 1 | Cat 1 & 2 | Cat 1 & 2 | Cat 1 & 2 |
| Approx. Weight | 545 | 590 | 710 | 760 | 870 |
| No. of cutting edges | 2 | 2 | 2 | 2 | 2 |
| Maximum HP | 45 | 75 | 75 | 75 | 75 |

IN STOCK Model ROB72 ONLY \$716

STARLINE TANDEM AXLE TANK SPREADER



\$3,650

DO YOUR OWN LOGGING With A 3 Pt. PTO CABLE WINCH

- Approx. 250 Ft. Of Cable
- 3 Ton Pull



\$545

BINKLEY & HURST BROS. INC.
SALES PARTS SERVICE

133 Rothsville Station Rd., Lititz, PA 17543
Located 1/2 Mile North of Rothsville
(717) 626-4705
Hours: Mon.-Fri. 7 AM - 5 PM; Sat. 7 AM - 11:30 AM
Sun. Closed - Lord's Day