

# CASE IH

## HAY AND FORAGE EQUIPMENT

**The efficient way to high quality feed production.**

If you are in the dairy or beef business and raise all or part of your hay and forage, you owe it to yourself to find out what Case IH has to offer in equipment. Case International hay and forage equipment can help you harvest and preserve your crops when they're at their highest nutritional value. See your dealer for equipment that has the crop-handling capacity to enable you to move fast when a crop is ready to be baled or chopped.

**You'll see:**

- Two advanced design self-propelled windrowers - the only ones in the industry offering three distinct types of interchangeable headers.
- Sickle-bar mowers, and mower-conditioners including models with 12 and 14 ft. widths (3.7 and 4.3 m) for acre-eating capacity, plus dual rakes that reduce trips over the field while keeping your haymaking on schedule.
- Rectangular balers offering up to 19 tons (17,252 kg) per hour capacity, plus round balers that let one man produce up to 18 tons (16,344 kg) of 6 foot (1.8m) diameter bales per hour.
- Advanced design forage harvesters with six interchangeable crop units including a 90-inch (2.3m) hay pickup that handles big, wide swaths with ease.

So see your Case International dealer and have him help you choose the equipment best suited for your operation. And remember, he'll be there after the sale to back you up with the best in parts and service.

Balanced Head Mowers

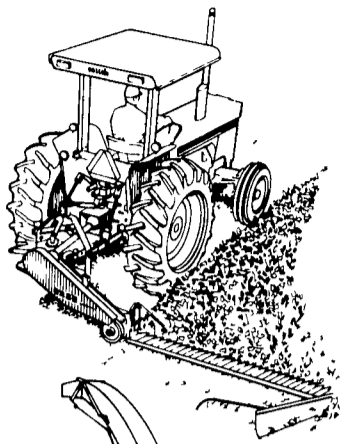

781/881 Forage Harvesters

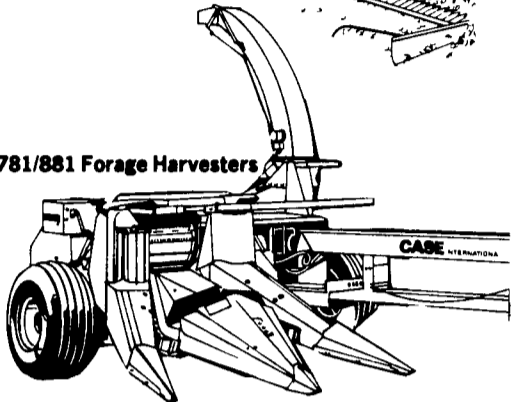

435 Twine-Tie Baler

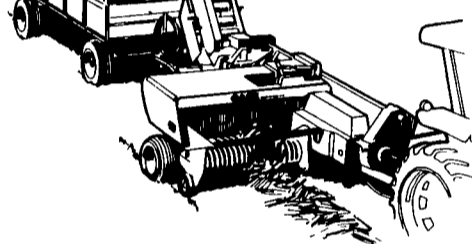

1490/1590 Mower Conditioner

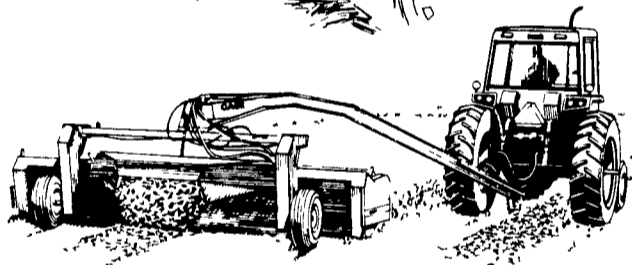

96/97 Dual Rakes

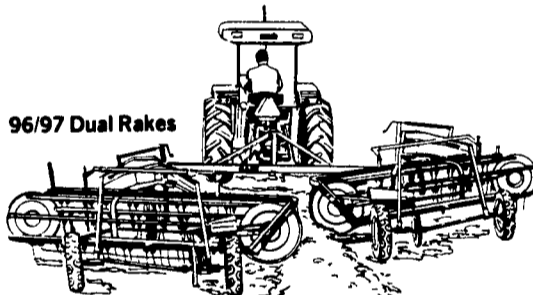

5000 Windrower

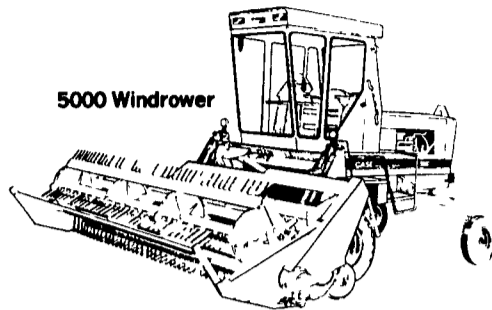

600 Forage Blower

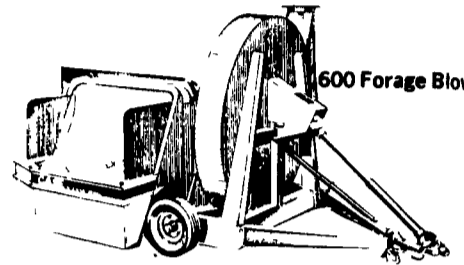

1190 Mower Conditioner

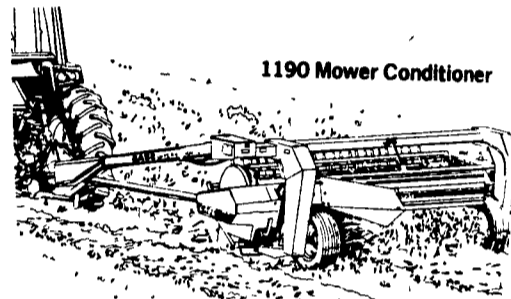

3650 Round Baler

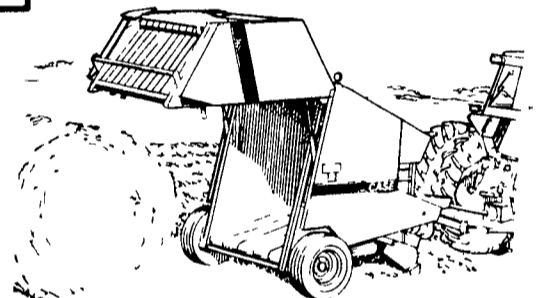

**SEE YOUR DEALER NOW!**

**5% APR FINANCING  
OR  
WAIVER OF INTEREST UNTIL 5/1/87  
OR  
ADDITIONAL DISCOUNTS**

**TRI COUNTY EQUIPMENT**

Rt. 40 & 557  
Vineland, N.J. 08360  
609-697-1414

**MELVIN J. SHEFFER, INC.**

121 Railroad Street  
Hanover, PA  
717-637-3808

**COASTLINE, INC.**

Rt. 537 & 524  
Freehold, N.J. 07728  
201-780-4600

**LAMB'S FARM MACHINERY**

Thorndale, PA  
215-269-2676

**COOPERS HDWE, INC.**

Turbotville, Pa. 17772  
717-649-5115  
1-800-441-FARM

**CLARENCE WILSON & SON**

Kimberton, PA  
215-933-3581

**MANOR EQUIPMENT, INC.**

Wheatfield, PA 18356  
Sinking Spring, PA 19608  
215-678-0828

**SIVERS EQUIPMENT CO.**

Wyalusing, PA  
717-746-3355

**M & R EQUIPMENT, INC.**

New Park, PA  
717-993-2511

**HINES EQUIPMENT**

Cresson, Pa. 16630  
814-886-4183

**BENDER IMPLEMENT CO.**

Somerset, PA  
814-443-4611

**VOUGH & SONS, INC.**

Bangor, PA  
215-588-5922

**ERB & HENRY EQUIP., INC.**

22-26 Henry Ave.  
New Berlinville, PA  
1 Mile North of Boyertown  
215-367-2169

**INCH EQUIPMENT CO.**

McAllisterville, PA  
717-463-2191

**A.L. HERR & BRO.**

312 Park Ave.  
Quarryville, PA  
(717) 786-3521

**C & P FULTZ EQUIPMENT**

Rt. 45 East  
Spring Mills, Pa. 16875  
814-422-8805

**C.H. WALTZ SONS, INC.**

Cogan Station, PA  
717-435-2921

**WM. HOBENSACK'S SONS**

1060 Greeley Ave.  
Ivyland, PA  
215-675-1610  
215-343-2101

**MORRIS INTERNATIONAL INC.**

Everett, PA  
814-652-6101

**BIGGS INCORPORATED**

34 Buckley Ave.  
Rising Sun, MD  
301-658-5531

**R.S. HOLLINGER & SON**

Mountville, PA  
717-285-4538

**LIGONIER SALES & SERVICE**

Ligonier, Pa. 15658  
412-238-5790

**WARNER TRACTOR & EQUIPMENT, INC.**

Troy, PA  
(717) 297-2141

**CARLISLE FARM SERVICE**

260 York Rd.  
Carlisle, PA 17013  
717-243-4419

**ECKROTH BROS. FARM EQUIP.**

RD 2, New Ringgold, PA  
717-943-2131

**HICKORY INTERNATIONAL INC.**

Route 1 Hickory  
Bel Air, MD  
301-838-4200

**HOOBER EQUIP., INC.**

Middletown, DE  
302-378-9555

**FARM-RITE INC.**

Shiloh, NJ  
609-451-1368

**MIFFLINBURG FARM SUPPLY**

Route 45  
Mifflinburg, PA  
717-966-3114

**C.B. HOOBER & SON**

Intercourse, PA  
717-768-8231

**BINKLEY & HURST BROS.**

133 Rothsville Station Rd.  
Lititz, PA  
(717) 626-4705

**MESSICK FARM EQUIP.**

Rheems Exit Rt. 283  
Elizabethtown, PA  
717-367-1319

**NORMAN BRIGHT**

New Egypt, NJ  
609-723-0300

**GEORGE W. KINSMAN, INC.**

516 Main St.  
Honesdale, PA 18431  
717-253-3440

**RINGTOWN FARM CO., EQUIPMENT**

RD #1 Box 3A  
Ringtown, PA  
717-889-3184