

CASE IH

Balanced Head Mowers

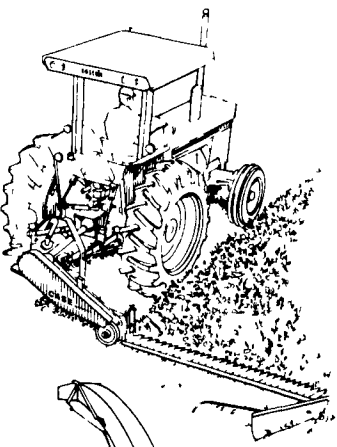

781/881 Forage Harvesters

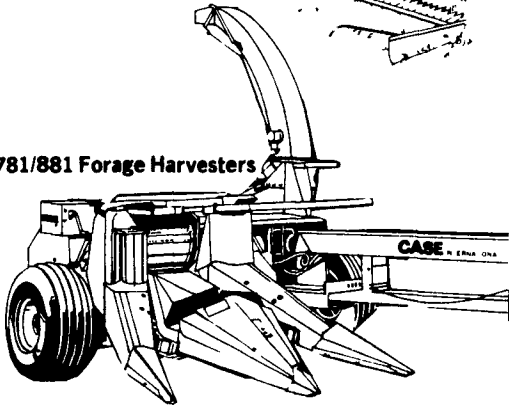

435 Twine-Tie Baler

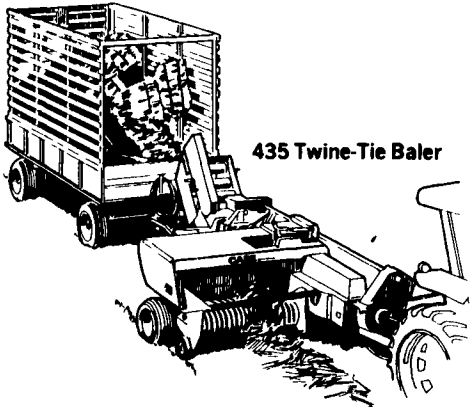

1490/1590 Mower Conditioner

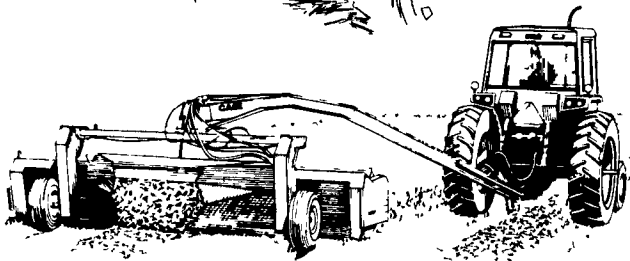

HAY AND FORAGE EQUIPMENT

The efficient way to high quality feed production.

If you are in the dairy or beef business and raise all or part of your hay and forage, you owe it to yourself to find out what Case IH has to offer in equipment. Case International hay and forage equipment can help you harvest and preserve your crops when they're at their highest nutritional value. See your dealer for equipment that has the crop-handling capacity to enable you to move fast when a crop is ready to be baled or chopped.

You'll see:

- Two advanced design self-propelled windrowers - the only ones in the industry offering three distinct types of interchangeable headers.
- Sickle-bar mowers, and mower-conditioners including models with 12 and 14 ft. widths (3.7 and 4.3 m) for acre-eating capacity, plus dual rakes that reduce trips over the field while keeping your haymaking on schedule.
- Rectangular balers offering up to 19 tons (17,252 kg) per hour capacity, plus round balers that let one man produce up to 18 tons (16,344 kg) of 6 foot (1.8m) diameter bales per hour.
- Advanced design forage harvesters with six interchangeable crop units including a 90-inch (2.3m) hay pickup that handles big, wide swaths with ease.

So see your Case International dealer and have him help you choose the equipment best suited for your operation. And remember, he'll be there after the sale to back you up with the best in parts and service.

5000 Windrower

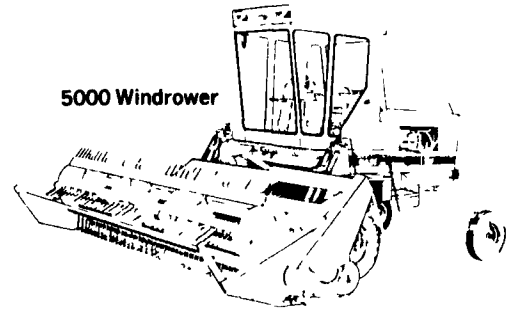

600 Forage Blower

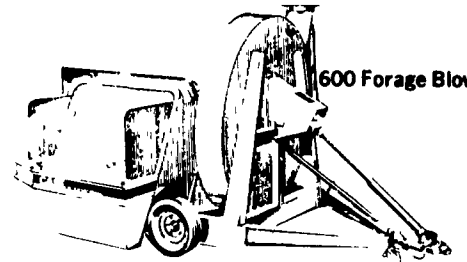

1190 Mower Conditioner

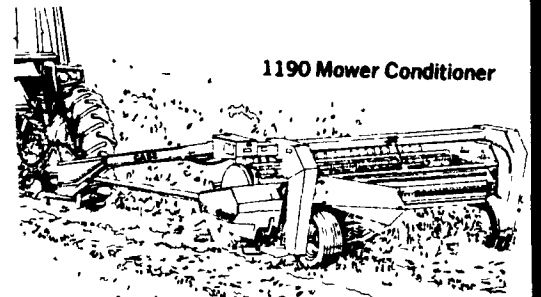

96/97 Dual Rakes

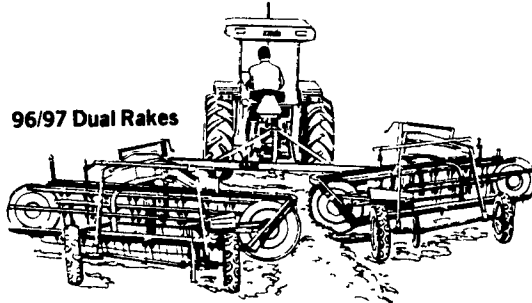

3650 Round Baler

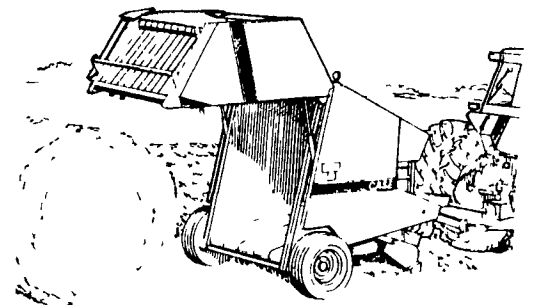

SEE YOUR DEALER NOW!

TRI COUNTY EQUIPMENT

Rt. 40 & 557
Vineland, N.J. 08360
609-697-1414

MELVIN J. SHEFFER, INC.

121 Railroad Street
Hanover, PA
717-637-3808

COASTLINE, INC.

Rt 537 & 524
Freehold, N.J. 07728
201-780-4600

LAMB'S FARM MACHINERY

Thorndale, PA
215-269-2676

COOPERS HDWE, INC.

Turbotville, Pa 17772
717-649-5115
1-800-441-FARM

CLARENCE WILSON & SON

Kimberton, PA
215-933-3581

MANOR EQUIPMENT, INC.

Wheatfield, PA 18356
Sinking Spring, PA 19608
215-678-0828

SIVERS EQUIPMENT CO.

Wyalusing, PA
717-746-3355

M & R EQUIPMENT, INC.

New Park, PA
717-993-2511

HINES EQUIPMENT

Cresson, Pa 16630
814-886-4183

BENDER IMPLEMENT CO.

Somerset, PA
814-443-4611

VOUGH & SONS, INC.

Bangor, PA
215-588-5922

ERB & HENRY EQUIP., INC.

22-26 Henry Ave
New Berlinville, PA
1 Mile North of Boyertown
215-367-2169

INCH EQUIPMENT CO.

McAllisterville, PA
717-463-2191

A.L. HERR & BRO.

312 Park Ave.
Quarryville, PA
(717) 786-3521

C & P FULTZ EQUIPMENT

Rt. 45 East
Spring Mills, Pa. 16875
814-422-8805

C.H. WALTZ SONS, INC.

Cogan Station, PA
717-435-2921

WM. HOBENSACK'S SONS

1060 Greeley Ave
Ivyland, PA
215-675-1610
215-343-2101

MORRIS INTERNATIONAL INC.

Everett, PA
814-652-6101

BIGGS INCORPORATED

34 Buckley Ave.
Rising Sun, MD
301-658-5531

R.S. HOLLINGER & SON

Mountville, PA
717-285-4538

LIGONIER SALES & SERVICE

Ligonier, Pa. 15658
412-238-5790

WARNER TRACTOR & EQUIPMENT, INC.

Troy, PA
(717) 297-2141

CARLISLE FARM SERVICE

260 York Rd.
Carlisle, PA 17013
717-243-4419

ECKROTH BROS. FARM EQUIP.

RD 2, New Ringgold, PA
717-943-2131

HICKORY INTERNATIONAL INC.

Route 1 Hickory
Bel Air, MD
301-838-4200

HOOPER EQUIP., INC.

Middletown, DE
302-378-9555

FARM-RITE INC.

Shiloh, NJ
609-451-1368

MIFFLINBURG FARM SUPPLY

Route 45
Mifflinburg, PA
717-966-3114

C.B. HOOPER & SON

Intercourse, PA
717-768-8231

BINKLEY & HURST BROS.

133 Rothsville Station Rd
Lititz, PA
(717) 626-4705

MESSICK FARM EQUIP.

Rheems Exit Rt. 283
Elizabethtown, PA
717-367-1319

NORMAN BRIGHT

New Egypt, NJ
609-723-0300

GEORGE W. KINSMAN, INC.

516 Main St
Honesdale, PA 18431
717-253-3440

RINGTOWN FARM CO., EQUIPMENT

RD #1 Box 3A
Ringtown, PA
717-889-3184