

**FEEDER WAGONS**

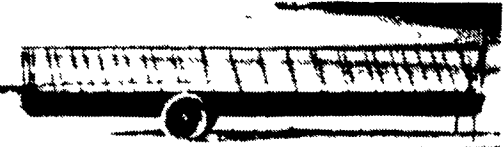

16', 21', 27' lengths available. A great feature for feeding cattle in meadows or in feed lots. Can be used for feeding round bales.

If old gas tanks are used for feeder wagon bottoms, they should be sand blasted. If not, the gas and rust may result in sick cattle or even death. Be safe and buy from us as ours are sand blasted before being painted.

Custom Built Cow Trough Dividers - Gutter Grates & Cattle Guards

\* Also Headlocks & Rack Wagons

**STOLTZFUS MANUFACTURING**

RD 1 - Honey Brook, PA 19344

215-273-3050 or 215-273-3603

Dealer Inquiries

**FOR SALE  
SCARE  
CANNONS**  
If you have a bird  
problem. Call me.  
**301-687-0608**

Larry's Tool Outlet  
Up to 80% savings Quality name  
brand tools featuring Easco KD  
Tools  
Open Tues 11 AM 5 PM  
Wed Sat 11 AM 8 PM  
431 Harrisburg Ave  
717-394-1400 or  
392-3392  
Also buy and sell used tools

**USED EQUIPMENT**

JD 2940 Tractor  
6' 3 pt. Hitch Scraper  
JD 54 3 PTH Rotary Mower  
2 Wheel Trailer  
5 Bottom 16" JD Model 1450  
1 Row Corn Head

**WENGER IMPLEMENT, INC.**  
Quarryville, PA 17566  
717-284-4141

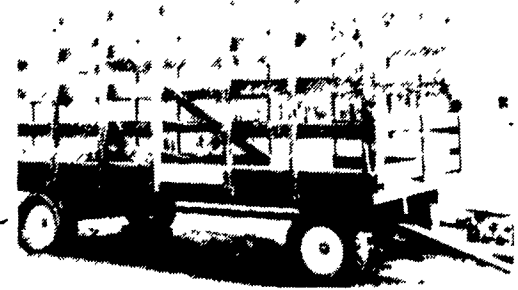

**Horning Built Hay Wagons**  
Oak Wood, Painted Green  
with gear

8'Hx8'Wx16'L ..... \$925.00  
8'Hx8'Wx18'L ..... \$1025.00

**Luke Z. Horning**  
R.D. 1, Newmanstown, PA 17073  
717-949-2147



8 & 9 Ft Kelly Baggers  
Custom Bagging  
Manure Spreaders  
Wagon & Auger Mix  
Live Floor  
Bovr-Jak 20-Cows  
2 Used H 190 Baggers  
2 3/4 Yd Mighty Bites  
AIA 8 & 9 Ft Sing &  
Duis - Flided  
W/H 2 Yrs Guarantee  
4-5-6 Ft. Bale Bags  
**AG PRODUCTS  
COMPANY**  
234 Johnston's Lane  
Mercersburg, PA 17236  
PHONE  
**717/328-3177**

**CASE 580C CAB WITH  
STANDARD BACKHOE**

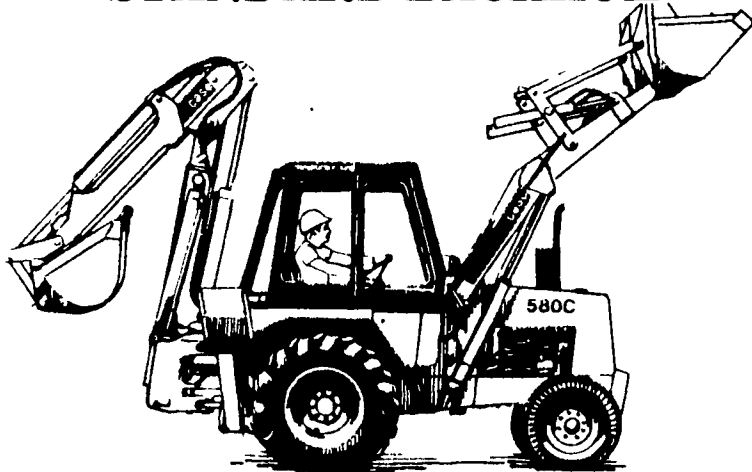

1976 Model w/Wobble Stick Controls  
**\$15,800**

**CATEGORY I  
3 POINT  
LIFT  
CARRIER  
ONLY  
\$45.00  
In Stock**

- Angle iron construction
- Lower link pins included
- Attaches to 3 pt. hitch of Category 1 tractors

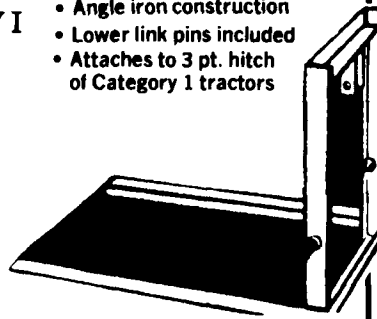

**SPECIAL NEW 3 PT.  
HOOKUP SAW BUCK**

Most Models Are  
Priced Over \$800

**OUR  
PRICE ONLY \$450**



**3 PT. ROUND BALE SPEAR**



SBC  
SOUTHEAST Brand

Weight: 105 Lbs.

Take Your Pick  
ONLY \$130 EA.

**SPECIAL  
ON NEW  
3 PT. HOOKUP  
POST DIGGERS**

• w/9" Digger  
\$325

• w/12" Digger  
\$345

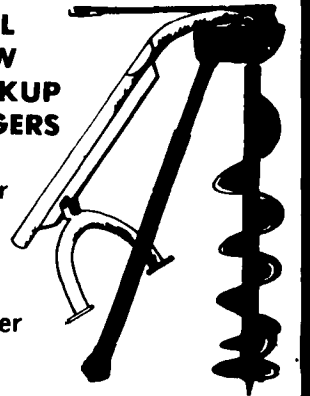

**THINK SPRING...  
We Have A Good Selection Of  
ROTARY MOWERS in Many  
Brands And Sizes At  
Discount Prices**

- **RHINO** SE4 3 Pt., 4' ..... \$425
- SE5 w/Pan, 5' ..... \$495
- SE7 w/Pan, 7', Slip Clutch .. \$1,196

- **BUSH HOG** 4', 3 Pt. Squealer ... \$475
- 6' Squealer w/Slip Clutch ..... \$785

- GT Trailer, 42" w/8 HP Briggs & Stratton Engine, Flotation Tires ..... \$825
- Trailer-Type 10'6" 3126R Manual Lift Rear Band, 2 Laminated Wheels, Single Axle ..... \$3,595
- 15' Bat Wing w/6 Laminated Tires, Rear Band, Hydraulic Lift And Wing Fold ..... \$6,495
- IMC 5', 3 Pt. Lawn-Type Rotary Mower ..... \$695
- IMC 6', 3 Pt. Rotary Mower ..... \$525
- South East RC 120 Drag Pull-Type 10' Rotary Cutter w/15" Used Auto Tires ..... \$2,390
- Challenger 6' Lawn-Type Mower w/Front Roller ..... \$1,275
- Woods 5' F35 H234 Belly-Mount ..... \$1,295

**3 PT. ECONOMY STONE RAKES  
w/GAUGE  
WHEELS**

- 6 Ft. .... \$395
- 7 Ft. .... \$410
- 8 Ft. .... \$425

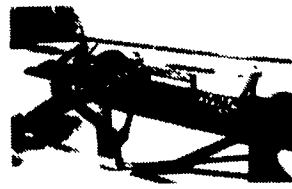

Coming Soon

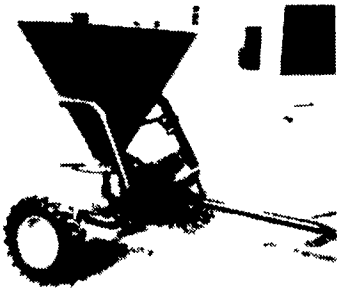

**NEW  
PULL-TYPE  
FERTILIZER/  
SEEDER  
SPREADER**  
In Stock  
**\$495**

**NEW! 3 PT. Fertilizer Spreader and  
Seed-Caster**



Accurately Broadcasts All Powdered And Granular Fertilizers and Herbicides, Seeds, Salt and Sand  
• Spreads up to 40 ft swath  
• Rugged all steel construction  
• Epoxy finish protects against rust and corrosion  
• Instant on/off

Choice of 3 Spread Patterns  
• Left • Full Rear • Right Spread

- 1M MODEL 1010 10 Bushel Size ..... \$329.00
- 1M MODEL 610 6 Bushel Size ..... \$284.00

**3 PT. ECONOMY STONE RAKES  
w/GAUGE  
WHEELS**

- 6 Ft. .... \$395
- 7 Ft. .... \$410
- 8 Ft. .... \$425



**MODEL  
3350  
AugerMatic  
Spreaders  
In Stock**



AUGER AGITATION  
POSITIVE UNLOADING  
HEAVY DUTY UNDERCARRIAGE  
OPTIONAL INJECTION ATTACHMENTS  
List Price \$12,240

**DISCOUNT  
SALE PRICE \$7,980**

*All Setup w/Tires & Ready To Go!*



**NOTICE:  
Is There  
Anybody Out  
There Who  
Could Use A  
NEW  
MOLDBOARD  
PLOW AT  
50% OFF??**

**TWO AVAILABLE:**

- 6 Bottom 18" Spring Trip (Not Auto. Reset) Semi-Mount Type, No Hyd. **\$3,900**
- **LESS 50%  
Means You Pay Only \$1,950**

**BINKLEY & HURST BROS., INC.**

133 Rothsville Station Rd., Lititz, PA 17543  
Located 1/2 Mile North of Rothsville

**PH: 717-626-4705**

Hours: Mon.-Fri. 7 A.M. - 5 P.M.;  
Sat. 7 A.M. - 11:30 A.M. Sun. Closed - Lord's Day