



1st ANNIVERSARY SALE

Automotive and Sporting Goods

Get Heavy Duty Shocks
For A Firmer Ride At
Higher Speed

Maremont Corp., Makers of
GABRIEL SHOCKS

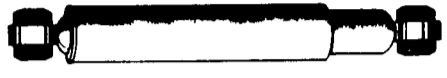

- Big 1 3/16" Bore Shock
- 40% Larger Than 1" Original Equipment
- Heavy Duty Means Smoother Ride

SALE **\$7.99** Each
\$31.99/PAIR, INSTALLED



OIL TREATMENT

- Fights motor oil breakdown
- Gives your oil muscle
- Add an anti-wear anti-oxidant agent for an extra measure of protection
- First time you need oil & every time you change oil, add STP Oil Treatment

GAS TREATMENT

- Saves gas • Cleans carburetors
- Removes water • Fights gas line freeze
- STP the name you can trust in car care products

YOUR CHOICE **\$1.59**

Oil Reg. \$1.99
Gas Reg. \$1.89



WD 40 Spray Lubricant

- Stops Squeaks
- Protects Metals
- Loosens Rusted Parts
- Frees Sticky Mechanisms

• 9 oz. Reg. \$2.09
1st ANNIVERSARY SALE..... \$1.39
• 12 oz. Reg. \$2.59
1st ANNIVERSARY SALE..... \$1.89
• Gallon Reg. \$10.99
1st ANNIVERSARY SALE..... \$8.99

Get Quicker, Better Response
With Gas-Charged Shocks

Maremont Corp., Makers of
GABRIEL SHOCKS



- "Booster Spring" Effect Helps Minimize Vehicle Sway
- Variable Resistance Reduces "Bottoming Out"
- Gas Reduces Shock Noise

SALE **\$12.99** Each
\$42.99/PAIR, INSTALLED



WINDSHIELD WASHER ANTI-FREEZE

Safe To -20°
**1st ANNIVERSARY
SALE**

88¢ Gallon

SUN TIMING LIGHT

CP7520-
TIMING LIGHT

- Replaceable Xenon Flash Tube
- Unbreakable Case

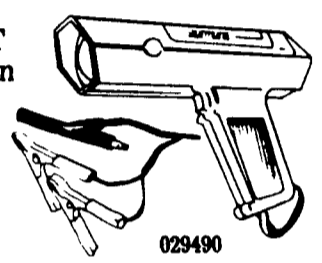

Reg. \$25.99
**1st ANNIVERSARY SALE
\$17.99**

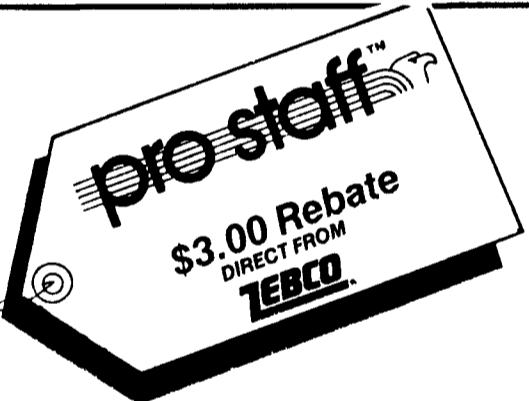

ZEBCO PS20 PRO STAFF REEL

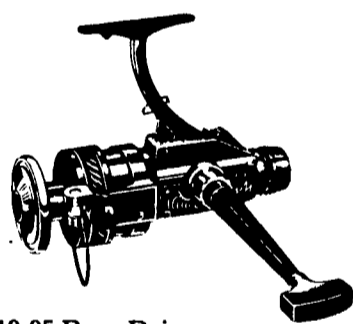

\$19.95 Reg. Price
\$14.95 SALE PRICE
- 3.00 REBATE From Zebco
\$11.95 NET COST

Medium Weight
Freshwater Spinning Reel
Graphite Spool, Ball
Bearings, Brass Gears

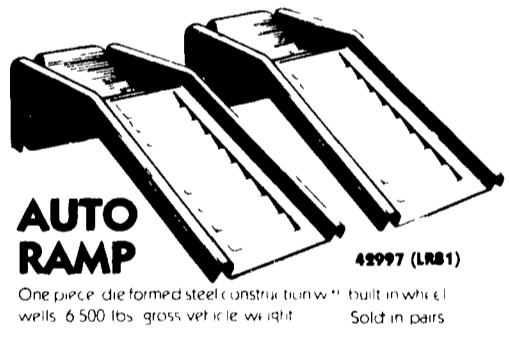

AUTO RAMP

One piece die formed steel construction built in white wells 6,500 lbs. gross vehicle weight Sold in pairs

Reg. \$12.99
**1st ANNIVERSARY
SALE
\$6.99**

Reg. \$21.99
**1st ANNIVERSARY
SALE
\$13.99**

The top quality
economy creeper
on the market

PLYWOOD MECHANICS CREEPER

- WITH NYLON CASTERS
- 15" wide x 36" long
- Siderails are recessed to accommodate the 1/4" plywood



SHAKESPEARE 'UGLY STICK' FISHING RODS



- 1100 SERIES**
- The World's Toughest, Most Sensitive Tubular Rods.
 - Patented Double-Bilt™ Graphite/Fiberglass Construction

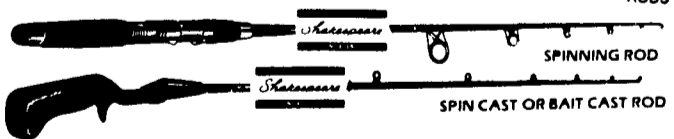

\$33.88 Reg. Price
\$24.88 SALE PRICE
- 5.00 MAIL-IN REBATE
\$19.88 NET COST



\$39.88 Reg. Price
\$29.88 SALE PRICE
- 5.00 MAIL-IN REBATE
\$24.88 NET COST

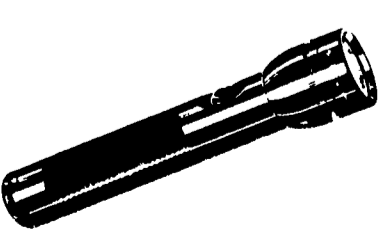

Mini MAG-LITE

- Unbelievable Brightness
- Adjustable Beam Control
- Only 5 1/2" Long
- Machine Tool Precision
- Turn The Head And It's On

Reg. \$13.59
1st ANNIVERSARY SALE..... \$10.99

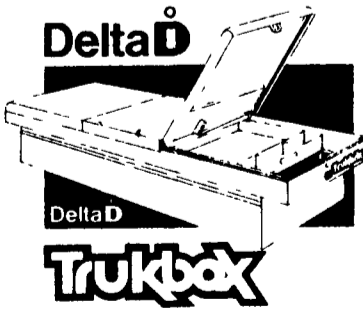

Delta D

Trukbox

TOOL BOXES
For Full Size, Compact & Stepside
Steel or Poly

YOUR CHOICE **\$79.00** Reg. \$99.00

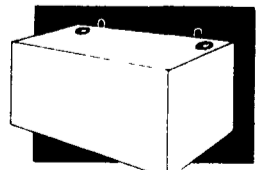

110 Gal.
FUEL STORAGE TANK
\$114.95
Reg. \$124.95

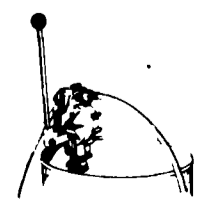

**PACER ALL-PURPOSE
PISTON PUMP**
\$64.95 Complete
Use For Fuel, Oil, Chemicals
Reg. \$76.14