

### CENTURY FARM DUTY MOTORS

- Single Phase • High Starting Torque • Manual Reset Overload Protector • Continuous Duty
- Totally-Enclosed Fan-Cooled • Double Sealed Ball Bearings Lubricated with Low Temperature Grease

We have a complete line of Century motors for the farm. Call or see us today for your farm motor needs.

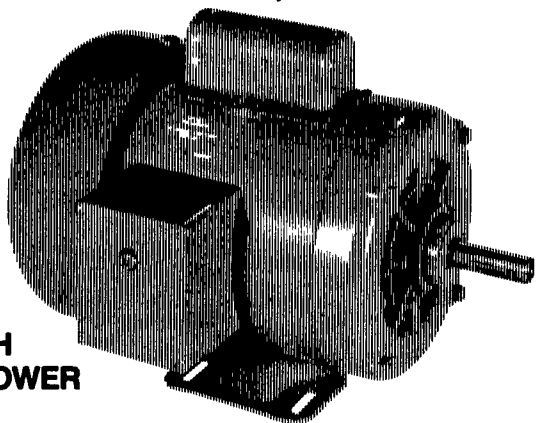

1/3 THROUGH  
1 1/2 HORSEPOWER

| Description                | Reg.     | SALE     |
|----------------------------|----------|----------|
| • 31524 1/3 H.P. Farm Duty | \$87.99  | \$74.99  |
| • 31525 1/2 H.P. Farm Duty | \$110.79 | \$99.99  |
| • 31530 3/4 H.P.           | \$120.99 | \$109.99 |
| • 31535 1 H.P.             | \$132.89 | \$119.99 |
| • 31540 1.5 H.P.           | \$162.89 | \$149.99 |

### LIVESTOCK PANELS



|                                   | Reg.    | SALE    |
|-----------------------------------|---------|---------|
| • 71420 52"x16' Cow Panel         | \$15.99 | \$14.39 |
| • 71405 60"x16' 4x4 Panel         | \$29.49 | \$26.99 |
| • 71410 52"x16' Combination Panel | \$17.99 | \$16.99 |
| • 71406 60"x16' 2x4 Horse Panel   | \$36.39 | \$33.99 |

### SUPER STRENGTH UDDER TOWELS

Great Heavy Duty Towel For Putting Pails  
A Proven Product!

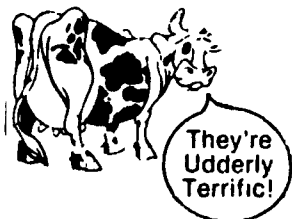

### SCHLUETER DAIRY TOWELS

• 4000/Case

Reg. \$34.69 SALE **\$28.99**

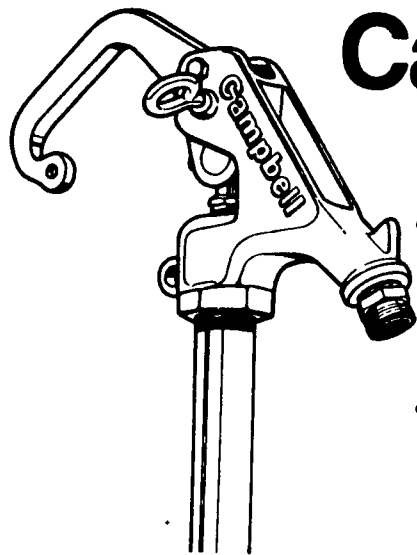

### Campbell water system products

#### YARD HYDRANTS

|                   |              |                     |
|-------------------|--------------|---------------------|
| • SKU 28976 3 Ft. | Reg. \$31.99 | SALE <b>\$26.99</b> |
| • SKU 28977 4 Ft. | Reg. \$33.99 | SALE <b>\$28.99</b> |

### Northern Signal ELECTRIC FENCER

| Description         | Reg.     | SALE     |
|---------------------|----------|----------|
| • 70485 Solar Blitz | \$135.79 | \$121.99 |
| • 70490 Scorpion    | \$48.59  | \$43.09  |
| • 70505 6/12        | \$43.59  | \$39.29  |
| • 70495 Weeder      | \$42.87  | \$38.79  |
| • 70510 Cow Trainer | \$40.09  | \$36.89  |

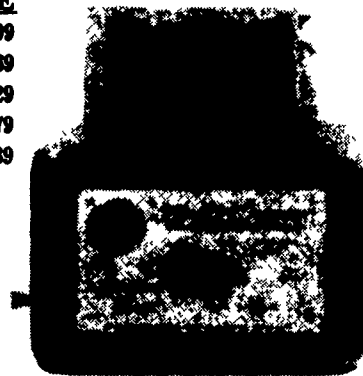

### ELECTRIC FENCE POSTS



- 3/8" x 48"
- 1 1/32" x 48"

SPECIAL..... **49¢**

### 50 LB. MILK REPLACER



| Description                         | Reg.    | SALE    |
|-------------------------------------|---------|---------|
| • 72135 24/10                       | \$19.00 | \$15.99 |
| • 72140 20/20                       | \$24.88 | \$21.99 |
| • 72145 20/14 Acidized              | \$33.68 | \$29.99 |
| • 72161 Nursing Bottle/<br>Snap Cap | \$2.39  | \$1.99  |

### Rubbermaid AGRICULTURAL PRODUCTS



#2645

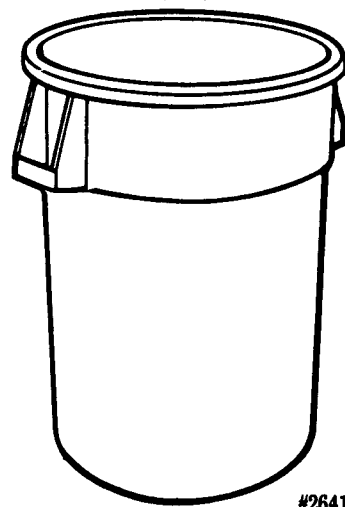

#2641

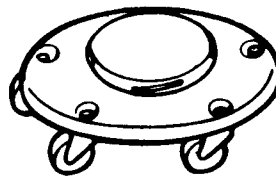

#2640

|                                 | Reg.    | SALE    |
|---------------------------------|---------|---------|
| • #2641 44 Gal. Brute Container | \$30.99 | \$24.99 |
| • #2645 Lid                     | \$8.49  | \$7.99  |
| • #2640 Dolly                   | \$25.79 | \$19.99 |

### IMPLEMENT JACKS

SKU 72002  
Model #10-T

Reg. \$23.49

1st ANNIVERSARY SALE

**\$17.99**

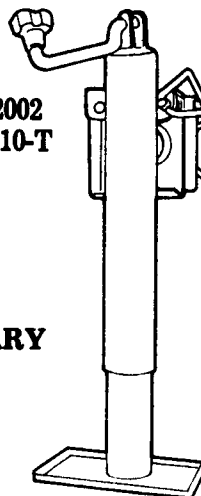

### PACER PUMP

• 73417 1 1/2" Reg. \$179.99

SALE... **\$149.99**

• 73413 2" Reg. \$179.99

SALE... **\$149.99**

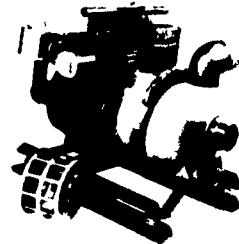

3" TRASH PUMP

75200

Reg...\$790.99

SALE ... **\$750.99**

### APPLEGATE LIVESTOCK GATES AND ROUND BALE FEEDERS

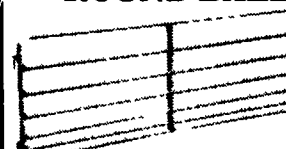

|                                   | Reg.     | SALE     |
|-----------------------------------|----------|----------|
| • 70035 H.D. Round Bale Feeder    | \$119.99 | \$109.99 |
| • 70040 Economy Round Bale Feeder | \$101.19 | \$91.99  |

H.D. 2" Tube Gates, 6 Rail

|             |         |         |
|-------------|---------|---------|
| • 74041 16' | \$83.89 | \$74.99 |
| • 74042 14' | \$74.59 | \$66.99 |
| • 12'       | \$62.99 | \$56.99 |
| • 10'       | \$60.69 | \$54.99 |

Feeder Gates

|                     |         |         |
|---------------------|---------|---------|
| • 70065 2"x10' Tube | \$56.99 | \$49.99 |
|---------------------|---------|---------|

### UNION DELUXE Long Handle ALUMINUM SCOOP

#14 Size  
15 1/4" x 19 3/4" blade  
40" 'D' handle

Reg...\$27.99

SALE

**\$20.99**

