

COME SEE OUR FLEET OF TRUCKLOAD SAVINGS

The Surprising Store

CENTRAL FARM & FAMILY CENTER

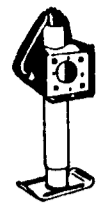
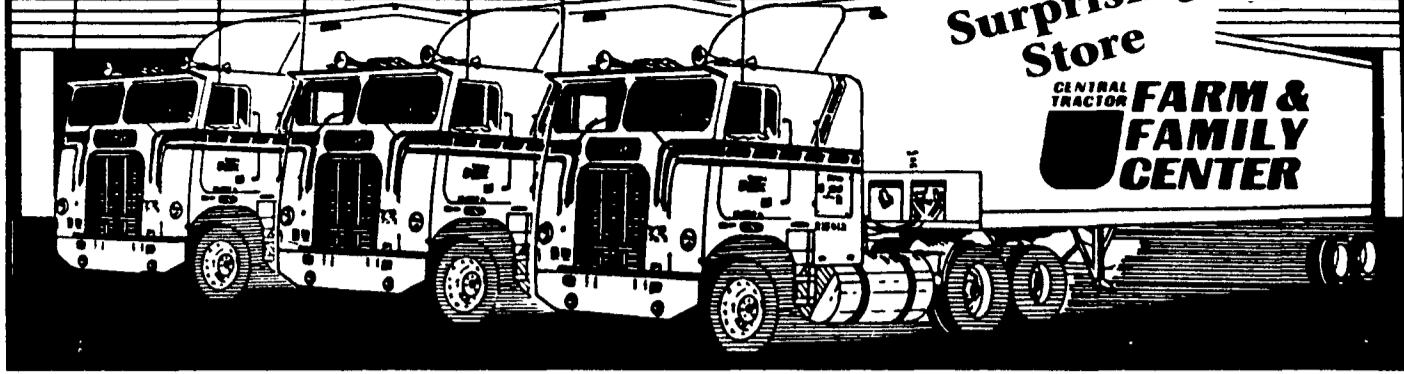

16⁹⁹

12656 040
Swivel Jack
• Assembly may be turned 90° horizontal or vertical
• Locking handle holds device in any position
Tubular Connection Swivel Jack
12655 040 **SALE 24.99**

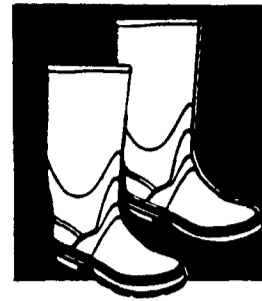

9⁹⁹

Reg 14.99 / SAVE 5.00
87700 164
P.V.C. Knee Boots
• Sizes 4-13

Adams Rock Shares
AS LOW AS **5⁹⁹** All 14



STAR HI-ACRE™ Rock Shares
AS LOW AS **5⁴⁹** All 14

BROKEN SHARE REPLACED FREE!
First 1/2" of wear

Applies only to Rock Shares
For All's Chalmers Case John Deere Ford IHC Massey Ferguson Oliver and Minneapolis Moline Made in USA
All 14" **5.99**
All 16" **6.49**
All 18" **6.99**

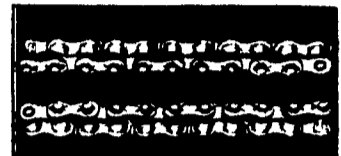

Roller Chain
10 Ft. Rollers
REGULAR ROLLER CHAIN

Type	Chain Pitch	Approx Width	Rollers per ft	Stock No	Reg	SALE
40	5 16	24	19	30011 024	12.49	7.99
50	5 8	3 8	19	30035 024	16.49	11.99
60	1 1/2	3 8	16	30050 024	22.99	15.99
2050	1 1/2	3 8	10	30119 024	12.49	9.99
2060	1 1/2	3 8	8	30126 024	16.49	12.99

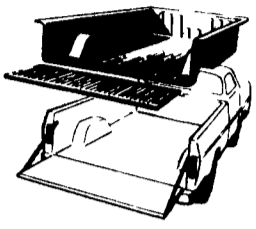

189⁹⁹

43038 472
Truckbed & Tailgate Liner
• One piece liner saves wear & tear on your pickup
• Resistant to gas of acids & salts
• Withstands temps to 100°F
• Tailgate cover included

BROKEN SHARE REPLACED FREE!
First 1/2" of wear

Applies only to Rock Shares
The extra heavy duty long wearing share is made of top quality spring steel. Extra material is added to the nose of the share making it wear twice as long and extra strong to eliminate breakage. Our extra heavy duty plow shares wear as long as any other share on the market. Rock Shares For All's Chalmers Case John Deere Ford IHC Massey Ferguson Oliver and Minneapolis Moline Made in USA

All 14" **5.99**
All 16" **6.49**
All 18" **6.99**

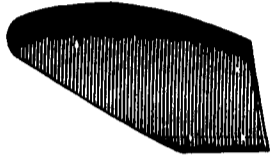

MOLDBOARDS
For Plows With Throw-A-Way Shares

Model	Mfg No	Stock No	NOW
Deere 14	HS314	16993 263	28.99
Deere 16	HS316	16994 263	34.99
John Deere NU 16	AA14685	16 99 263	38.99
Ford 14	104409	16996 263	32.99
Ford 16	104412	16997 263	35.99
IHC Super Chief 14	522328R1	16700 263	30.99
IHC Super Chief 16	522329	16701 263	33.99
IHC Super Chief Hi Speed 14	462313	16800 263	34.99
IHC Super Chief Hi Speed 16	462314	16801 263	35.99
Minn Moline or Oliver 14	R419 14	16766 263	33.99
Minn Moline or Oliver 16	R619 16	16767 263	34.99
Massey Ferguson 14	660010	16998 263	31.99
Massey Ferguson 16	660204	16999 263	33.99

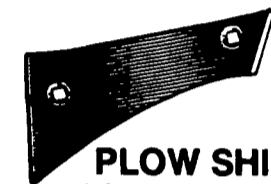

PLOW SHINS
For Plow Bottoms using Blade Type Shares

Drop forged out of high carbon steel added thickness is forged where severest wear is encountered. Order bolts separately as shin price does not include bolts.

Model	Mfg No	Stock No	NOW
All's Chalmers 14 or 16	324940	16007 002	5.99
All's Chalmers 375 series 14 or 16	340971	16053 002	5.99
All's Chalmers 387 series 14 or 16	347648	16063 002	5.99
Case 14	W105445	16008 002	5.99
Case 16	W165485	16038 002	4.79
Ford Economy 12 14 or 16	104403	16009 002	4.29
David Brown 14 or 16	HS105	16084 002	6.29
John Deere RH 14	8195A	16010 002	3.89
John Deere NU 14 or 16	NU / 8196A	16098 002	4.79
IHC (S.C.) 14 or 16	522325R	16012 002	4.99
IHC (P.C.) 14 or 16	515680	16772 263	6.79
Massey Ferguson 14 or 16	680020-M91	16013-002	4.29
Massey Ferguson 14 or 16	475191	16783-263	5.29
Massey Ferguson 387 series 14" or 16"	16013-002	16013-002	4.29
Minn Moline 14 or 16	20F40	16766-263	4.99
Oliver 12 14 or 16	7488 (new)	16015-002	5.29
Oliver 12 14 or 16	490 (used)	16016-002	4.29

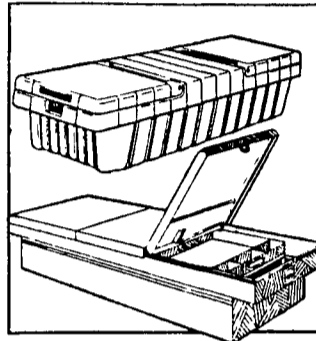

79⁹⁹

Steel or Poly Pickup Tool Box
Fits most standard pickups
Steel Tool Box 22185 269
Polyethylene Tool Box 43210 472
L Shaped Fuel Tank 199.99
100 Gal 22-04 269 Reg 169.99
Steel or Poly Mini Pickup Box
Fits Datsun Luv Toyota Scout Courier GMC S15 Chevy S10 & Ford Ranger pickups
Steel Tool Box 22205 269
Polyethylene Tool Box 43227 472
L Shaped Fuel Tank 104.99
75 Gal 22-259 269 Reg 114.99

69¢ per lb
290 Series
Reg 79¢ / SAVE 12%
Assorted Nuts, Bolts & Flat Washers
Grade Two

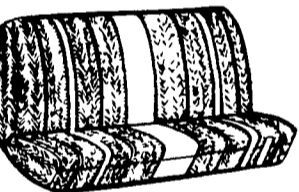
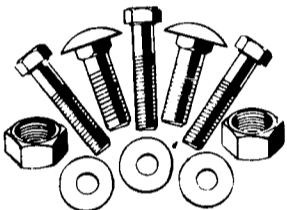

26⁹⁹

Pickup Truck Saddle Blanket Seat Covers
• Easy to install
• Fits all pickups
• Under knee rifle scabbard on full size only
• Front storage pockets
• Washable
• Black brown blue and wine colors

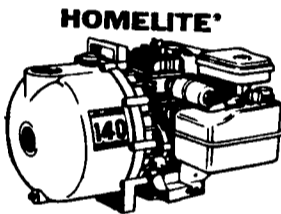

169⁹⁹

16812 100
3 HP Gas Powered Centrifugal Pump
• Self priming pump
• 110 gpm @ 30 psi
• NPT inlet & discharge
• Lightweight & portable
5 Hp x 2 Centrifugal Pump
18972 100 **NOW 214.99**



299⁹⁹

18326 106
1 Hp. Twin Cylinder Air Compressor
• 14 gallon tank 70 CFM disp
• 5.2 cfm at 40 psi
• 4.2 CFM at 90 psi
• V 2 twin cylinders
• Easy to read gauge enables you to dial the pressure desired no additional regulator needed
15 Air Hose 17791 106 **NOW 7.99**
25 Air Hose 16400 106 **NOW 10.99**
50 Air Hose 8417 106 **NOW 21.99**

Black & Decker

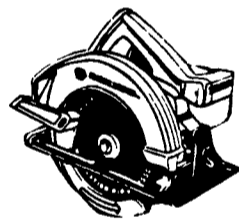

32⁹⁹

Reg 39.99 / SAVE 7.00
11104-087
Black & Decker® 7 1/4" Circular Saw
• Model 7308
• Double insulated front handle for positive control
• Ejection chute keeps sawdust away from cutting line
7 1/4" 4-tooth Enduro™ Blade 22230-177 Reg 5.99 **SALE 4.99**
7 1/4" 8-tooth Enduro™ Blade 22261-177 Reg 7.99 **SALE 6.99**

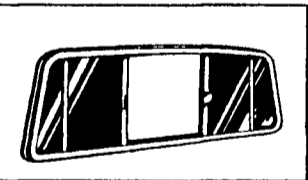

39⁹⁷

(472 Series)
Clear Glass Pass-Thru Rear Cab Window
• Curved top frame for OEM fit
• Anodized aluminum frames
• Metal Center lock
• Applications include most popular makes & models
EZ Slider w/Tinted Glass
472 series **NOW 44.99**

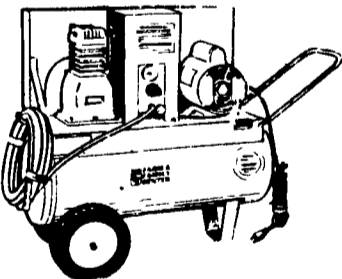

189⁹⁹

17980 106
1/2 Horsepower Air Compressor
• 10 gallon tank
• 3.2 CFM disp. 2.4 CFM at 40 psi 1.8 CFM at 90 psi
• Dial O Matic control
• No additional regulator needed

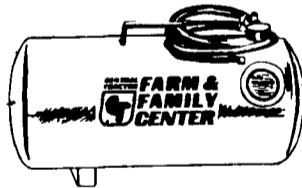

29⁹⁹

17784 106
Heavy Duty Air Tank
• Complete with 6 front tie up chock gauge and shifter valve
• 10 gallon tank

HYDRAULIC HOSE

• Two Wire Braid Hose
• Complete with 1/2" solid male fittings on both ends
• Hose with 7" bending radius and 3500 psi maximum working pressure

Length	Stock No	NOW
12 in	22527 105	3.49
18 in	22528 105	4.18
2 ft	22529 105	4.99
3 ft	22530 105	5.68
4 ft	22531 105	6.48
5 ft	22532 105	7.09
6 ft	22533 105	8.09
7 ft	22520 105	9.99
8 ft	22521 105	10.99
9 ft	22522 105	12.49
10 ft	22523 105	13.99
12 ft	22524 105	17.99
13 ft	22534 105	18.99
15 ft	22535 105	21.99

BATTERIES AS LOW AS 28⁹⁹

Group 22F
3 Year Guarantee Automotive Use

Guarantee	Volts	Cold Crank	Group	Exch Price
3Yr	12	350	22F	28.99
4Yr	12	400	22F	30.99
5Yr	12	440	22F	35.99
3Yr	12	350	24/24F	29.99
4Yr	12	400	24/24F	35.99
5Yr	12	500	24/24F	41.99
3Yr	12	350	74	32.99
5Yr	12	500	74	42.99
2Yr	6	480	1	30.99
3Yr	6	525	1	34.99
2Yr	12	715	4DLT	83.99
4Yr	12	485	27/27F	39.99
5Yr	12	565	27/27F	46.99
2 1/2 Yr	12	580	30	55.99
2 yr	12	450	3ET	51.99



Tractor and Commercial
Guarantee 1/2 The Time On Group
22 24 27 and 74 Batteries Many
Other Batteries Available At
Special Low Prices

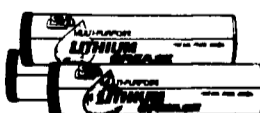

55¢ each

in cases of 25 only
Reg 65¢ / SAVE 15%
65¢ individually
13999 272
14 oz. Lithium Grease Cartridges
• Top quality multi service
• 25 cartridges per case
35 lbs. Lithium Grease
13998 272 **SALE 21.99**



379

Reg 429 / SAVE 11%
9854 069
Grease Gun
• Uses cartridge or bulk grease
• All steel
• 2 way plunger



1450

27800 285
50 Lbs. Milk Replacer
Higher quality than many milk replacers on the market. Compare for yourself and see the difference the quality can make in your animals.



Towing Chain

5/16" x 14'	14⁹⁹
10608 072 Reg 18.99	
3/4" x 14'	19⁹⁹
10600 072 Reg 24.99	
5/16" x 14' Hi Test	19⁹⁹
10751 072 Reg 22.99	
3/4" x 14' Hi Test	24⁹⁹
10749 072 Reg 31.99	
5/16 x 20' Binder Chain	29⁹⁹
• DOT app. oved 11082 072 Reg 39.99	



16 11 ga plain blade
Heat Treated Plain Disc Blade
18 11 ga **NOW 5.49**
18 9 ga **NOW 6.99**
20 9 ga **NOW 7.49**
20 7 ga **NOW 8.49**
22 7 ga **NOW 11.99**
24 x 1/4 **NOW 18.99**



Notched Blades
16 11 ga **NOW 4.49**
18 11 ga **NOW 5.99**
18 9 ga **NOW 6.99**
20 9 ga **NOW 7.49**
20 7 ga **NOW 8.99**
22 7 ga **NOW 11.99**
24 x 1/4 **NOW 18.99**

"EVERY DAY LOWER PRICES"

CENTRAL FARM & FAMILY CENTER

THESE PRICES WILL BE HONORED ONLY

AT THE LANCASTER, PA STORE
SALE MON., JAN. 27 THRU SAT., FEB. 8 LANCASTER
1570 Manheim Pike, Ph. 717/569-0111
8:30 a.m. to 5:30 p.m. Mon. thru Fri.
8:30 a.m. to 5 p.m. Sat.

All items are subject to stock on hand. We reserve the right to limit quantities. Sale ends on above date. Not Responsible For Printing Errors.