

Can't Afford New...
HERE IT IS IN GOOD USED

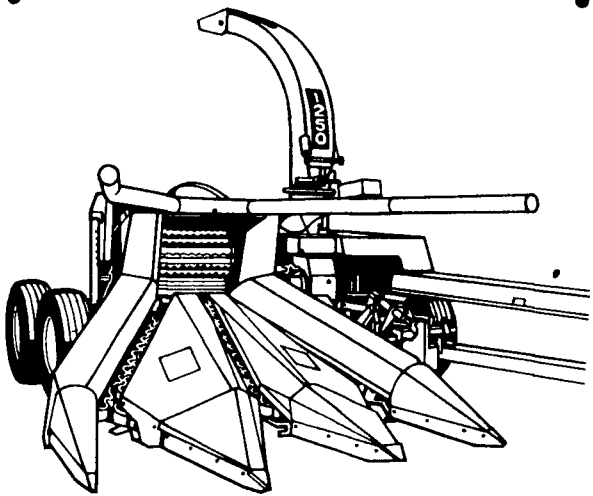

Super Capacity!

High performance, quality and super capacity describe the new 1250 forage harvester from Gehl! Outstanding features include reversing one-way shear bolts on feed roll drives, a new single station shear bar adjustment, a more rigid drawbar, and a new disc-less blower for easier fan blade adjustment. See us today for more information on the new Gehl 1250 forage harvester.



- Used Gehl Model CB1250 Chopper w/2 Row Cornhead & 7 Ft. Hay Pickup
\$13,800
- Used Gehl Model CB1200 Chopper w/New 2 Row Narrow Cornhead
ONLY \$8,950

**USED JOHN DEERE
MODEL 714
FORAGE BOX**

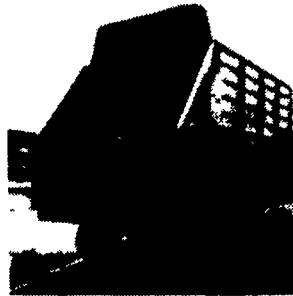

Good Condition
ONLY \$3,395⁰⁰

**LIKE NEW EARCORN
SNAPPER HEAD**
for NH 770-782
Call (717) 626-8324
Lancaster County

**LIKE NEW
STEEL BALE WAGONS**

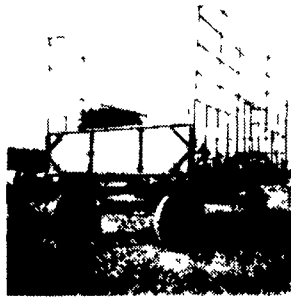

(2) Danco Steel, 8'x16' Long, Bale Rack on 8 Ton McCurdy Wagon w/New 9.5Lx15 8 Ply Tires w/Quick Hitch. Ready To Go!

EACH \$2,090

GLENCOE FIELD CULTIVATORS

The Ideal Machine To Prepare For Fall Seeding

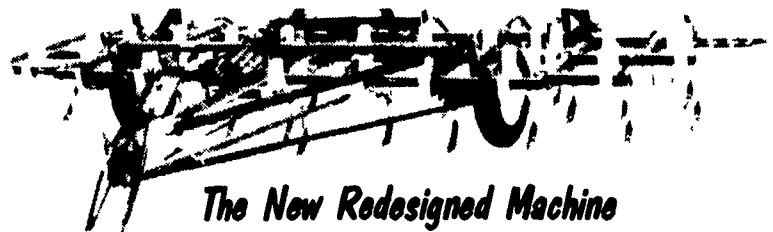

The New Redesigned Machine

- IN STOCK No Hydraulics In Prices
- 11'6" Model P18-21 \$1,922.00
 - 12'6" Model P18-23 \$2,069.00

**BEHLEN
CORN CRIBS**

NOTICE! The Prices Have Gone Up, But Our Present Inventory Will Go At The Old Prices Until Depleted
**SO DON'T WAIT!
SAVE NOW**

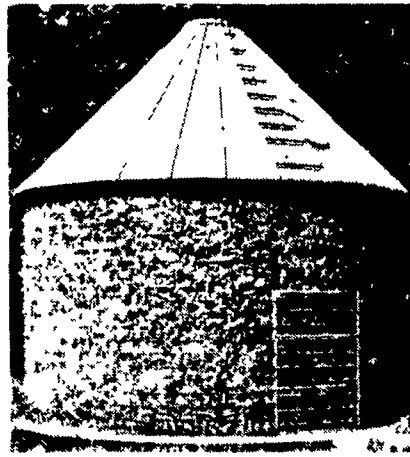

- Model FXL-15 865 Bushel plus extra capacity in roof area
- Model-EL - 101085 bushels plus extra capacity in roof area
- Model-EXL-15 1515 bushels plus extra capacity in roof area

Did You Know Behlen Corn Crib is No. 4 gauge, which is heavier than most other brands and helps to prevent bulging of sides.

**NOTICE! Are You A Farmer
Who Demands
HIGH CROP CLEARANCE**

Here It Is In 4 WD Power



NEW CASE MODEL 1394 65 HP DIESEL

In Stock! Come And See

Get 2.5% 5 Year Lease

SPECIAL OFFER

**NEW CASE
1494**

**ONE OF
A KIND**

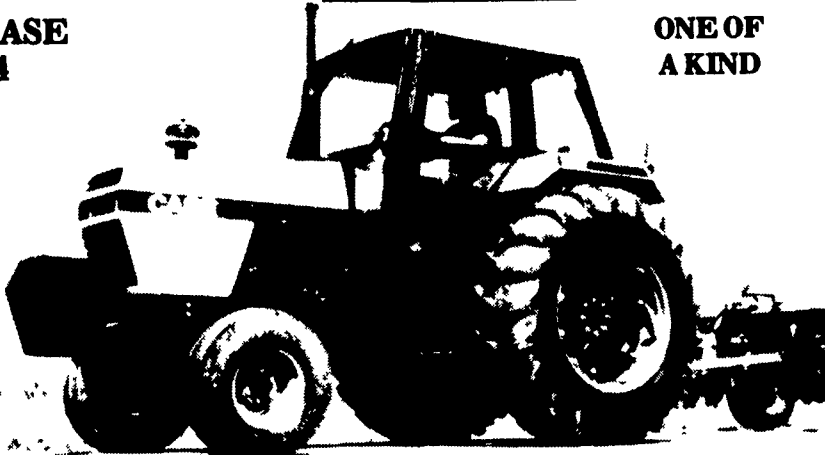

Cab, Air Conditioning, Heater, Power Shift
75 HP TURBO CHARGED DIESEL

18.4x34 Rear Tires Manual Adjustable, Twin Hyd. Remote Outlets, One w/Float Detent, w/Weight Frame But No Weights, Reversible 540-1000 PTO
Serial #11192364

\$27,900 With 2.5% 5 Year Lease Is A Deal You Shouldn't Miss! NOW IS YOUR TIME!

This Is Your Golden Opportunity...DON'T MISS IT!

NEW CASE MODEL 2090 108HP PLUS



Cab, Air, Heater, Power Shift (Duals & Weights Optional)
20.8x38 Rear Tires (No Other Options Or Weights)
Factory List \$48,051

BRAND NEW... Buy \$48,051 Value And Quality

FOR ONLY **\$28,850**

And Get This: Lease At Only 2.5% For 5 Years

Annual Payment Each Year = \$6,058.50

CALL FOR COMPLETE DETAILS

BARGAIN HUNTER'S SPECIAL

Don't Buy Any Auger Unloading Forage Box Until You See Our Continuous Drive

**GEHL
ECONOMICAL UNLOADING
FORAGE BOX**

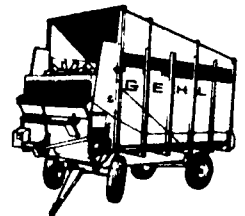

Gehl's 640 self-unloading forage box gives you high capacity unloading for quick field-to-silo-to-field cycles. Time-saving features include front safety bar and side safety cables for quick shutdown, plus a large 16' cross conveyor auger that unloads the heaviest loads quickly, evenly. For economical unloading, stop by and see the Gehl 640 forage box today!

NEW GEHL 640 BOX, 6'x16' Long, Roof & 3 Beaters, Serial #3518, Mounted on New Heavy Duty McCurdy 10 Ton Wagon w/Adjustable Quick Hitch Tongue and 11Lx15 8 Ply Tires. Reg. Price \$5083
Less Cash Disc. Of \$217.00 If You Pay During Sept.

Means You Pay Only **\$4,866**

BINKLEY & HURST BROS., INC.

133 Rothsville Station Rd., Lititz, PA 17543

Located 1/2 Mile North of Rothsville

PH: 717-626-4705

Hours: Mon.-Fri. 7 A.M. - 5 P.M.;

Sat. 7 A.M. - 11:30 A.M. Sun. Closed - Lord's Day