

USED EQUIPMENT

IH 656 Tractor
Disk Harrows
Grain Drills
IH 686 Tractor

4 Bt. 3 Pt. Hitch Plow
4 Bt. 2 Pt. Hitch Plow
Used Combines

Norman Bright Inc.

45 Evergreen Road New Egypt, N.J.
609-723-0300

FOR SALE!

- MF 1085 w/Multi Power
- Hesston 420 SP Windrower, 12 Ft. Head
- Grove For. Wgn. w/ Roof
- Hesston 5600 Rd. Baler
- 1977 Ford 1/2 Ton Pickup

★ Call After 5 PM ★
717-263-4692

TRACTOR & MOTOR REPAIRS
Over 20 years experience with Ford tractors and equipment. Shop & Road Service Pickup and Delivery

WALT STIVELY, JR.
Springville Road
Quarryville, RD 3
Phone: 717-786-2252



NEED MORE ROOM?
Read The Classified Real Estate Ads

FARM EQUIPMENT

FARM EQUIPMENT

FARM EQUIPMENT

MESSICK FARM EQUIPMENT, INC.

Farm Equipment Is Our Business
RHEEMS EXIT, RT. 283, ELIZABETHTOWN, PA.

PH: (717) 367-1319 Toll Free In PA. 1-800-222-3373 Warren Spickler-Home 653-4560 We Ship UPS



Mounting and Dismantling Was Never Easier

International® 2250 Mount-O-Matic Loader

2250 Mount-O-Matic has a 10 1/2-foot dump and is ideal for 40 to 80 horsepower tractors.



INTERNATIONAL HARVESTER

A GOOD SELECTION OF USED EQUIPMENT

IH MODEL 600 FORAGE BLOWER
Capacity to match tall silos

• 30.5 inch extendable hopper for

easy drive-in convenience

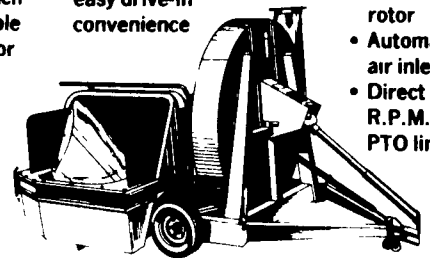

• 60" diameter rotor
• Automatic air inlet
• Direct 540 R.P.M. PTO line

• Wheels adjust for clearance, leveling and height

ATTENTION FARMERS: If Parts Are Needed After Hours To Keep You Going, Call Jay Gainer, Our Parts Mgr. At Home 367-7926

HAY & FORAGE

- IH 56 Blower, HD PTO
- AC Model K Combine w/Platform & 3 Row Corn Head, Ex Cond
- NH 892 Harvester w/919 N3 Corn Head
- NH 479 Haybine
- NI 5 Reel Rake
- IH 650 Harvester w/Pickup & Corn Head
- (2) Dion Forage Box Wagons
- IH 1190 Mower Conditioner
- NH 2 Row Snapper Head
- Gehl 600 Harvester 2 Row & Pickup

- New Idea 1 Row Corn Picker (Nice)
- NH 880 Harvester w/2 Row Corn Head
- NH #8 Forage Box & 234 Wagon
- HD Big Bale Mover
- IH 60 Shredder 6 Row
- IH 50 Shredder 4 Row
- Owatonna 540 Stack Wagon, Excellent, Used less than 100 Loads
- Owatonna Stack Mower, Excellent, Used less than 100 Loads

- IH 225 SP Mower Conditioner
- NH 822 Corn Head
- NH 488 Haybine
- NH 315 Baler w/Thrower, Excellent, Like New
- AC 303 Baler
- NH 276 Baler w/Thrower
- JD 660 Rake

TRACTORS

- IH 340 Tractor, Fast Hitch
- IH 5088, 136 HP, 300 hrs
- IH Cub Lo Boy



AC Cleaner K, 10' platform, 3R narrow cornhead, excellent cond.

MISCELLANEOUS

- Grain-O-Vator Grain Cart
- Pequea Hay Tedder, 7 ft
- Little Giant 40 ft Elevator
- Herd Fertilizer Spreader & Seeder
- NH 352 Grinder Mixer

SKID LOADERS

- NH L425, Rental Unit
- NH L775 Diesel, Deutz 50 HP

TILLAGE

- JD 350 6 Bottom Plow
- IH 440 Plow, 4 Bottom 16" Demo
- IH 700 4 Bottom Auto Reset Plow
- Brillion 14 Ft. Transport Harrow
- Glencoe 9 Shank Soil Saver w/New Disc
- Brillion 10 Ft. Culti Packer
- IH 350 Disk Harrow, 12 ft. Nica
- JD 10 ft. Rotary Hoe

PLANTERS

- IH 400 Planter 6 or 4 Row
- White 4 Row Air Planter

SPREADERS

- NI 214 3 Beater Spreader
- NH 519 Spreader 2 Beaters, Hyd. Gate
- NH 516 Spreader
- NH 362 Tank Spreader
- NI 224 Spreader, 2 Beaters, 10 Ton
- NH 791 Spreader

MESSICK . . . YOUR HARVESTER SPECIALISTS

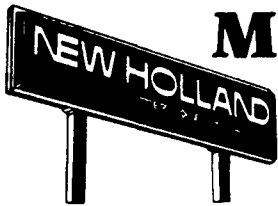

NH 782 FORAGE HARVESTER
Featuring THE METALERT™
NEW FOR '83!

The exclusive Metalert™ electronic metal detector prevents costly damage to the cutter head

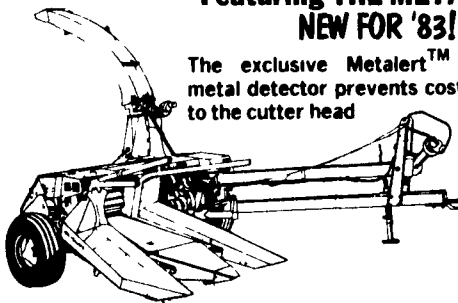

NH 892 FORAGE HARVESTER

Available with 2 or 3 Row Adjustable Corn Heads

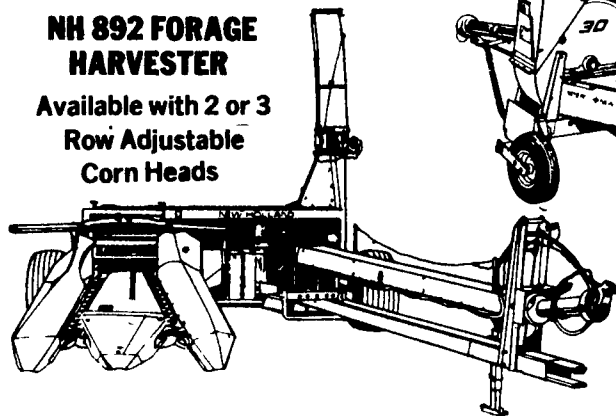

CHECK OUT THESE EXCLUSIVE FEATURES AVAILABLE ON ALL MODELS

- Metal Detectors
- Flip-Up Feed Rolls
- Heavy Duty PTO
- Electric Controls
- Double edge underbeveled Knives (never requires rebeveling)
- 2, 3 & 4 Row Harvesters, Have Adjustable Row Crop Heads

NH MODEL 1600 FORAGE HARVESTER

Will outcut most Self-Propelleds for about 1/3 the cost.

3 or 4 Row Corn Head

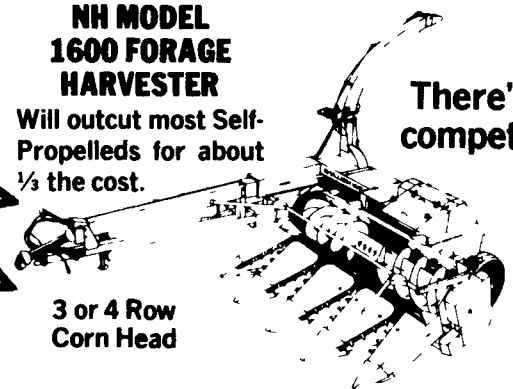

There's no competition

NH #8 CROP CARRIER

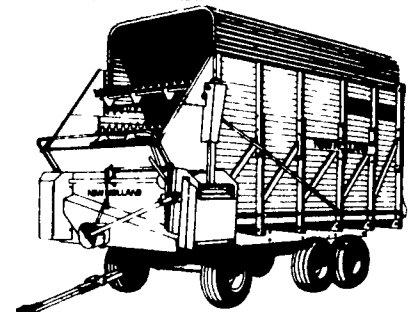

12 Ton Running, Flotation Tires

- Features:**
- Front & Rear Unload
 - Worm Gear Drive
 - Variable Speed Control
 - Heavy Duty Chains

NH 1900 FORAGE HARVESTER
A New Giant, 250 H.P. Strong

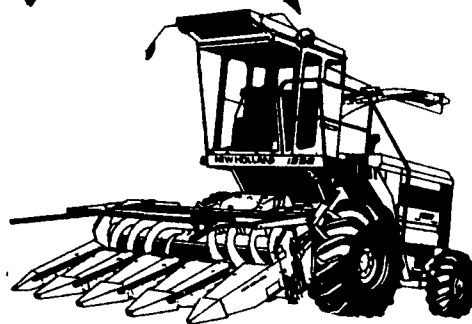

NEW PROGRAM:

- **WAIVER OF FINANCE** on HAY EQUIPMENT Till July 1, 1985
- **WAIVER OF FINANCE** on FORAGE EQUIPMENT Till Sept. 1, 1985
- **OR LOW RATE FINANCING** on NEW & USED EQUIPMENT

- 4.9% Financing For 1 Yr.
 - 7.9% Financing For 18 Mos.
 - 9.9% Financing For 24 Mos.
 - 11.9% Financing For 36 Mos.
 - 13.9% Financing For 60 Mos. (Self-Propelled Units Only)
- OR BIG CASH REBATES**



MESSICK FARM EQUIPMENT, INC.

RHEEMS EXIT — RT. 283, ELIZABETHTOWN, PA
PHONE: 717-367-1319, 653-8867
TOLL FREE IN PA. 1-800-222-3373
WARREN SPICKLER — HOME 653-4560
★ WE SHIP UPS