

NOTICE: SPECIAL SALE ON NEW & USED QUALITY HAY MACHINES In Stock And Ready To Work!

**20% OFF
GEHL...THE LEADER
IN FORGE BOXES**

In Stock
(Less Running Gears)

**NOTICE! TAKE
20% OFF**

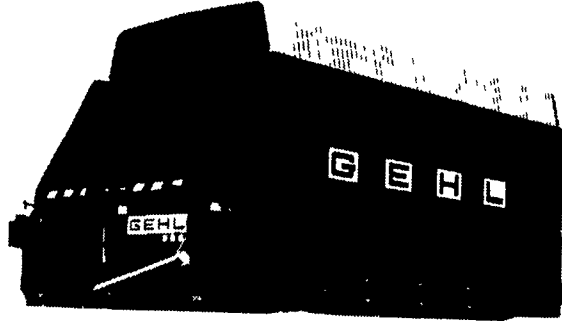

Special Serial Numbered New Forage Boxes In Stock
Shown In This Ad Only

- New Gehl 640 Wood Box 6'x14' With Roof With 3 Beaters, Rubber Trough Unloading Extension, Continuous Drive, Serial # 3434
FACTORY PRICE W/ FREIGHT & SETUP..... **\$4609¹⁶**
- New Gehl 640 Wood Box 6'x16' Long With Roof, Rubber Trough Unloading Extension, 3 Beaters, Continuous Drive Serial #3518
FACTORY PRICE W/ FREIGHT & SETUP..... **\$4843¹⁵**
- New Gehl Model 640 Wood Box 4'x16' 2 Beaters, No Roof, With Rubber Trough, Unloading Extension, Serial #3439
FACTORY PRICE W/ FREIGHT & SETUP..... **\$4041⁴⁶**
- New Gehl Model 640 Wood Box 4'x14', 2 Beaters (No Roof) With Rubber Trough Unloading Extension Serial #3423
FACTORY PRICE W/ FREIGHT & SETUP..... **\$3848⁰⁰**

NOW IS THE TIME TO SAVE BIG!!

Remember... 20% Off

BRAND NEW DEMONSTRATOR - IT REALLY WORKS!

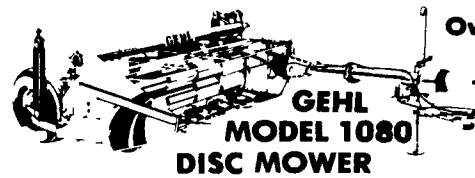

Over 10% OFF
This Machine Loves
Tangled, Heavy, Down
Crops

Cut condition and windrow up to 7'10" in even the heaviest crops with the 1080 disc mower conditioner from Gehl! Six counter rotating three knife discs slice through your crop at up to 54 000 cuts per minute, leaving your fields cut short smooth Intermeshing rolls aggressively grab the crop yet gentle condition it to speed drying and reduce leaf loss Stop by and see the high speed, efficient 1080 disc mower conditioner in action

Our Regular Low Price Is \$9,219.00

Serial #2447

NOW ONLY..... \$7,997.00

New Warranty

**Hurry! Now Is The Time To Own
The Top Of The Line!**

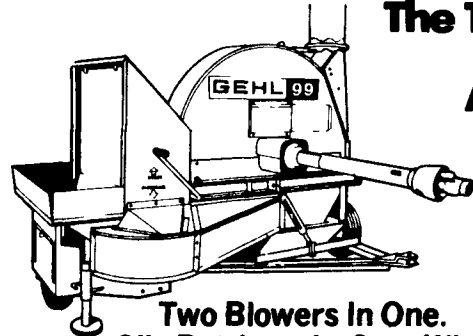

**A GOOD USED
GEHL 99
FORAGE
BLOWER**

Two Blowers In One.
Silo Bottlenecks Stop With
Optional Heavy Duty PTO Shaft.
3 To Choose From... Ready
For Delivery

FROM \$1580

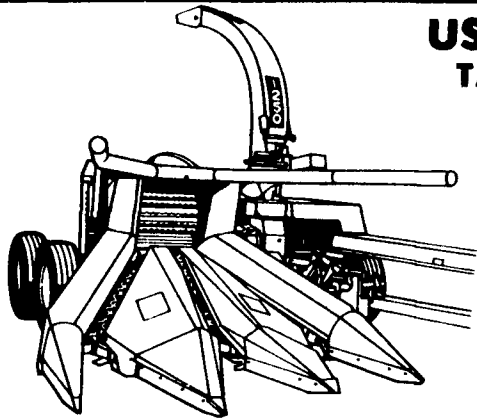

**USED CHOPPER SPECIALS!
TAKE 25% OFF PRICE BELOW!**

Completely Serviced & Field Ready

- Gehl 1200, 1000 RPM, Hyd. Controls, Hyd Knife Sharpener (Less Header)

SALE PRICE

\$7,800

Remember Deduct 25%

This machine designed to handle
from 90 HP up to 225 HP.

A Real Power Saver with Capacity to
handle 2 or 3 row headers.

**THIS KS 85 DEUTZ-FAHR HAY RAKE
HAS RAKED LESS THAN 15 ACRES!**



PTO DRIVE UNIT RAKES 9 Ft.

\$1375⁰⁰



**NEW IDEA
9 FT.
CUT-DITIONER**
w/High Flotation Tires

If Down And Tangled Hay Is
Frustrating You -
Take A Look At This
'Like New' Machine!

\$4450

Now Is The Time To Save On A
Beautiful, LIKE-NEW BALER That
Hasn't Even Been Broken-In!
Baled Less Than 2,000 Bales

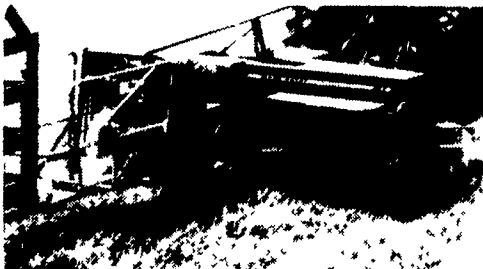

**JD MODEL 327 BALER
w/30 EJECTOR**

\$7900 Value - Make Offer

**SPECIAL OFFER
ROUND BALE FEEDERS
W/LOWER FEED SAVER
PANEL**

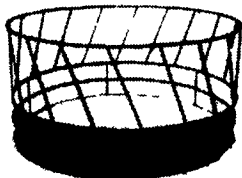

8" Dia. x 42" High
w/15" Feed Saver
Panel

Round Feeders are rugged constructed to give years of
feed saving service. Each feeder makes it possible to
feed nearly 100% of your big bales to over 20 head of
full grown cows. The nearly 100% Utilization of feed can
more than double you feed dollars.

SALE PRICE ONLY \$98.50

w/Short 4" Extension Legs To Keep Unit Above Mud

**DEUTZ FAHR
DRUM-TYPE (Used)
ROTARY MOWER**

9 Ft. Cut w/Tegral Hydraulic Lift
IDEAL FOR MOWING MEADOWS
AND DOWN CROPS

Reg. Price \$1928

SALE PRICE \$1680

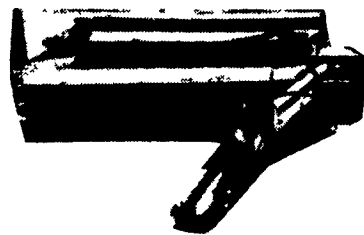

**WATER TANK ATTACHMENT
FOR HAYLAGE**

HOW ABOUT A PROVEN NEW IDEA THAT WORKS!

HAYLAGE WATER TANK Haylage gumming can plague every farmer, but it doesn't
have to anymore not with the addition of this special 300 gallon polystyrene
watertank to your Gehl hay pickup Total system includes corrosion resistant sen
sors and controls to start and stop waterflow as needed 30 gallons get you through
half a day of harvesting

They Really Help! In Stock - One Only Factory List \$611

DISCOUNT SALE PRICE \$498

**USED VICON DISK MOWER
7'8" Cutting Width \$4,670**

**BALER TWINE
IN STOCK**

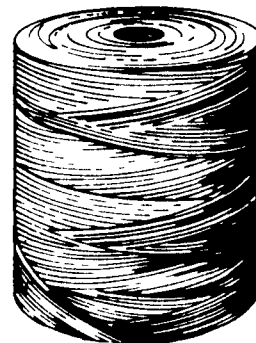

SISAL & PLASTIC

For Conventional
And Round
Balers

**CASE ECONOMICAL
3 PT. HITCH
ROUND BALE CARRIER**

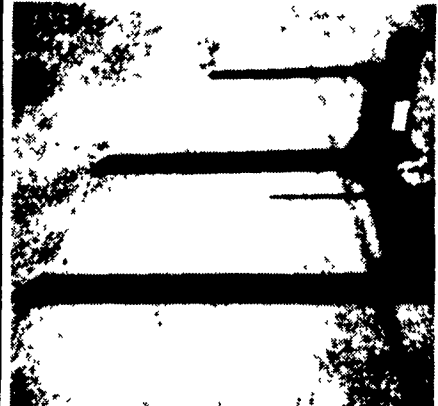

w/50" Long Prongs And
2 Ft. Upper Spike

\$289 Also Available For
Skid Loaders...\$489

MAKE US YOUR DEALER NOW!

BINKLEY & HURST BROS., INC.

133 Rothsville Station Rd., Lititz, PA 17543

Located 1/2 Mile North of Rothsville

PH: 717-626-4705

Hours: Mon.-Fri. 7 A.M. - 5 P.M.;

Sat. 7 A.M. - 11:30 A.M. Sun. Closed - Lord's Day