

Get Ready For September And SAVE... At Binkley & Hurst Bros. Now!

8.8% Financing Available On All Used Farm Tractors

10% OFF NEW & USED HARVESTING SPECIALS

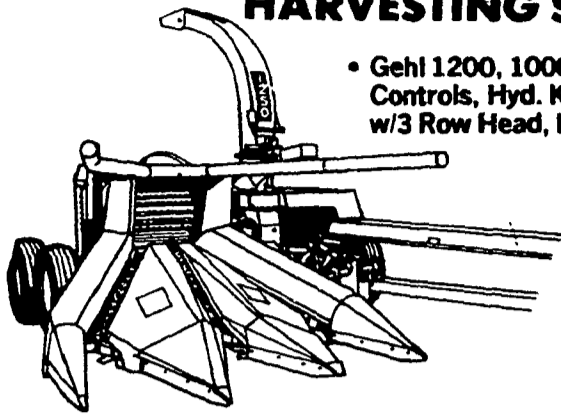

- Gehl 1200, 1000 RPM, Hyd. Controls, Hyd. Knife Sharpener w/3 Row Head, Excellent

SALE PRICE
\$10,800
Less 10%

- Hesston 7020, 540 PTO, 1 Row Corn Head, 5' Hay Pickup, Manual Controls. SALE PRICE .. **\$2780**
Less 10%
- New 700 Gehl Harvester, 540 PTO, Manual Controls w/Used 2 Row Corn Head Old Style. SALE PRICE **\$6,180**
Less 10%

FORAGE BOXES AND BLOWERS

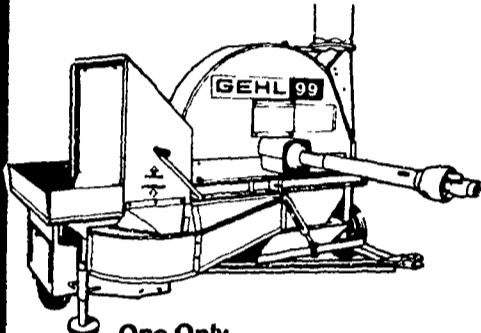

- New Gehl FB99 w/ Heavy Duty 540 PTO Shaft, Serial #18288

CASH PRICE
\$2,361
Less 10%

- One Only
- Cobey 6x16 3 Beater & Roof w/12 Ton Tandem Gear. SALE PRICE..... **\$1975**
Less 10%
- Case 100 Forage Hopper Blower SALE PRICE..... **\$595**
Less 10%

35% OFF

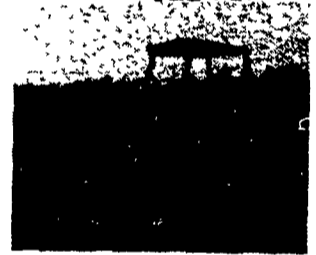

OWATTONA 1200A
Completely rebuilt, 30 HP Wisconsin engine, bucket & manure fork NICE. Reg. Price \$5,860
SALE PRICE \$3,809

CASE 1830 HYDROSTATIC UNI-LOADERS

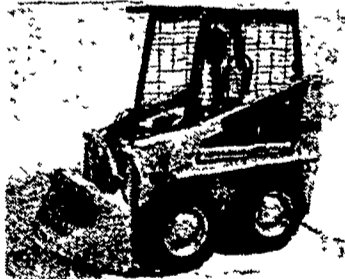

(1) S/N, 983 4144, 1977 Model, 60" Bucket, 7:00 15 Tires, Manure Fork
SALE PRICE \$6,900

BEAUTIFUL OWATTONA 1700 SKID LOADER



Equipped w/Ford Gas Engine, w/Bucket & Fork
Reg. Price \$5,860
SALE PRICE \$4,950



FORD CL-40 SKID LOADER
Ford V-4 gas engine, 60" bucket, canopy
3 To Choose From

- S/N 5434 **SALE PRICE \$5,957**
- S/N 3121 **SALE PRICE \$6,900**
- S/N 6563 **SALE PRICE \$7,649**

OWATTONA MODEL 330 SKID LOADER



Hyd. Drive, Approx. 25 HP
Reg. Price \$3,980
SALE PRICE \$3,750

20% OFF

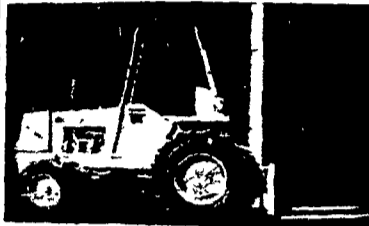

CASE 586C DIESEL
6000 lb. Forklift w/48" Pallet Forks Side Shifter, Only 1079 Hrs.
16.9x24 Tires, 14' Mast
Serial #9001042
Reg. Price \$17,900
SALE PRICE \$14,320

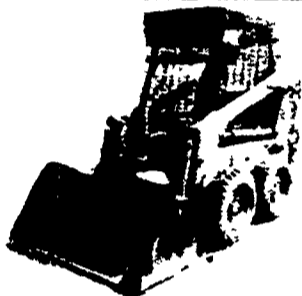

CASE 1737 UNI-LOADER
Narrow Tires, 37 HP, Quick-Tach Bucket, Water-Cooled Engine
Reg. Price \$4845
SALE PRICE \$3,876

CASE 1537 UNI-LOADER

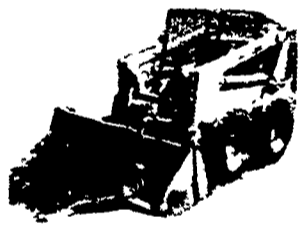

SALE PRICE \$3,900

FORD DIESEL MODEL 6500 LOADER BACKHOE



Cab w/Heater, Sold New 1976, 15 Foot Backhoe, 24" Trenching Bucket, About 7 Foot Loader Bucket, Self Leveling Loader, Approx. 2200 Hrs., Under Excellent Maintenance Program, Automatic Forward & Reverse w/3 Speed On The Go Power Shift, 18.4x28 Rear Tires, Approx. 50%

Reg. Price \$12,800
\$11,800
A GOOD SOLID MACHINE

SOME REAL BARGAINS

LOOK! There are 300 Horses Coming Your Way If You Buy This Like New Case 2870 4 Wheel Drive Tractor Now!



With on the go power shift transmission, 20.8x34 tires with factory 20.8x34 duals, 4 hydraulic remotes. PLUS 4-WAY SELECTIVE STEERING * Approx 825 Hrs. Ready For Hard Work
SALE PRICE \$33,800

FORD 8000 DIESEL



(No cab), Serial #C317978, approx. 1971 Model, Dual Power Transmission w/Filter Kit, 540 PTO, 3 pt. Hydraulic Remote Outlet, Approx. 4392 Hrs., 18.4x38 Rear Tires on Power Adjust Wheels, Engine Runs Good!

Ready For Your Field
SALE PRICE \$7,900

JOHN DEERE 2010 DIESEL

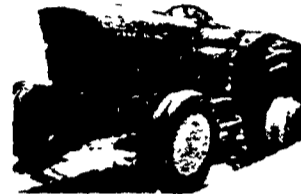

Low Clearance Utility Tractor, Approx. 46 HP Rating, Power Steering, 540 PTO, 3 Pt. Hitch With Square Type Liftarms, Hydraulic Remote Outlet, 16.9x28 Rear Tires, Approx. 80%, 3787 Hrs., Engine Doesn't Burn Oil

Reg. Price \$4850
SALE PRICE \$3,850



1980 Like New Case 4490 4 Wheel Drive Diesel Tractor with only about 565 hrs 20.8x34 radial tires 3 pt hitch, PTO, 4 remotes

SALE PRICE \$39,843

Good Used



1816B HYDROSTATIC UNI-LOADERS

(1) S/N 9846417, 44" Bucket, 28.5x15 Tires, Rebuilt Engine

SALE PRICE \$4,380



IH 560
Wide Front, New Hyd. Pump, Good TA, 16.9x38 Tires, 50%
Reg. Price \$3250
SALE PRICE \$2,850

DAVID BROWN 990



Engine A1, 53HP Diesel Select-A-Matic, A Beauty!
Reg. Price \$4800
SALE PRICE \$3,950

DEUTZ 4506 DIESEL

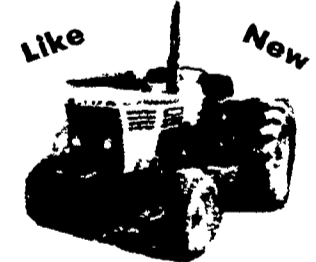

Like New
670 Original Hrs. Must See To Appreciate
Reg. Price \$7650
SALE PRICE \$6,980
8.8% Financing

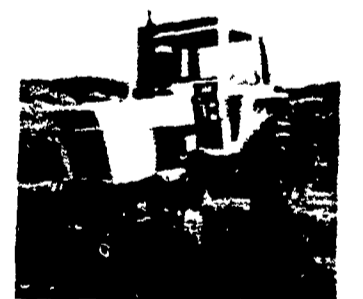

CASE 1070

MECHANICS SPECIAL

Diesel, Power Shift, 2,728 Hours, Serial #8710114

As Is **\$5,900**

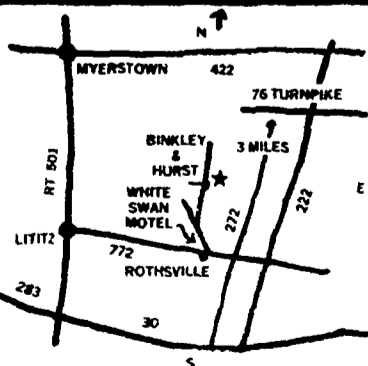

XT190 Allis Chalmers

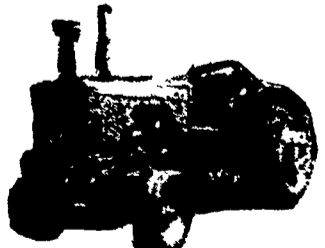

Hi-Lo Shift Rebuilt, 18.4x34 Tires
70% Reg. Price \$5900
SALE PRICE \$5,375

LOOK AT THIS! Compact Hough Tow

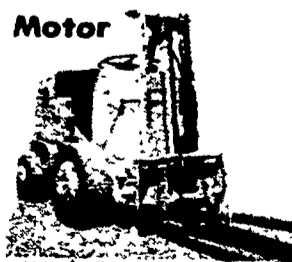

Motor
Rear Wheel Steering, Hard Rubber Tires, Large Drive Wheels On Front, Pallet Forks Approx. 36" Long, Engine Rebuilt 2 Years Ago, Lifts About 4 1/2 Feet High, Ideal For Warehouse Work, Ready For Work.
Reg. Price \$3,600
SALE PRICE \$1,900

SPECIAL - NEW FORAGE BOX

New Gehl Model 640

Roof, 3 Beater, 14 Ft. w/New McCurdy 8 Ton Wagon w/Adj. Quick Hitch, 11Lx15 8 Ply Tires

ONLY **\$4,681.00**

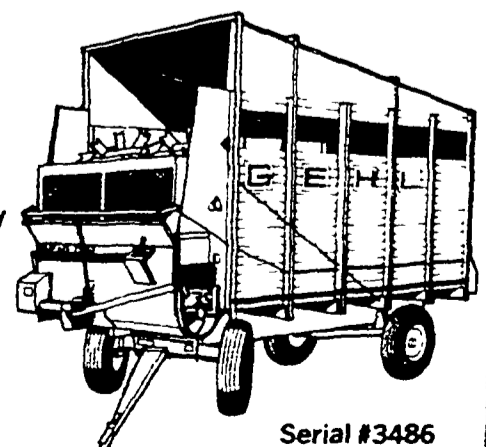

Serial #3486

BINKLEY & HURST BROS., INC.
133 Rothsville Station Rd. Lititz, PA 17543
PH: (717) 626-4705
Business Hours: Mon.-Fri. 7 AM - 5 PM; Sat. 7 AM - 11:30 AM