

FIELD DAY DEMONSTRATION

Thursday, June 2, 1983 10 AM to 3 PM

Rain Date June 3, 1983

Glenn Zimmerman Farm: 1 Mile East of Heisey Farm Equipment on Shirksville Rd.



NEW IDEA QUALITY PARTS AND SERVICE.

We Will Be Demonstrating The Following New Idea Equipment:

- NI 279 Cut-Ditioner
- NI 509 Mower Conditioner
- NI 406 Hay Rake
- NI 680 Forage Harvester
- NI 484 Bale King Round Baler
- NI 555 Rectangular Baler

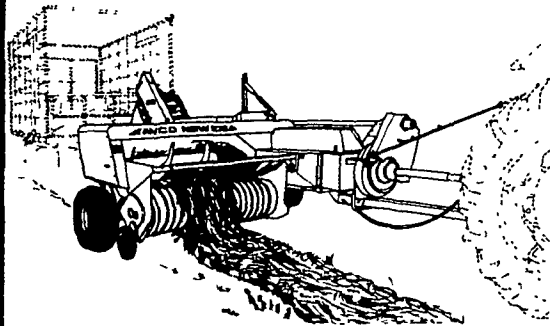

LET'S MAKE HAY!

If you're particular about the quality of the hay you make and demand tight, well tied, uniform bales in the up to 70 pound size, you owe it to yourself to see Avco New Idea's rectangular balers.

- Clean-sweep 65-inch pickup saves those valuable nutritious leaves and cleanly sweep the crop into the baler

See us soon to get all the facts about the complete line of Avco New Idea hay harvesting machines.

- Two models to choose from to bale up to 15 or 17 tons/hour
- Build firm, uniform bales that measure 14"x18"x12" to 48" long
- Optional bale thrower makes field operation a one-man job

Here's Your Free Profit Harvester Checklist

Look for high performance pull choppers with:

- Two models to choose from — 2 or 3-row harvesting capacity... up to 90" hay pickup
- Row crop heads that easily interchange with either a 72 or 90-inch hay pickup
- Convenient electrical controls that eliminate ropes, levers and cranks

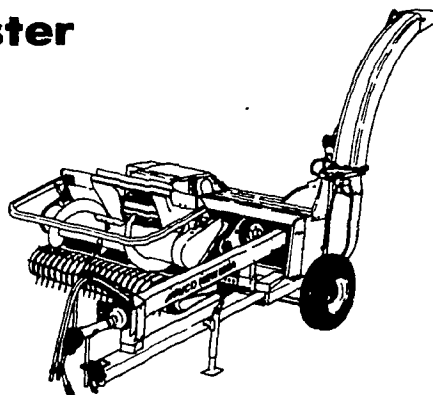

- Power efficient, fuel-saving, 12-knife cutterhead that can fine chop without fuel-robbing re-cutter screens

Look for all these advantages and find... Avco New Idea pull-type forage harvesters. See us soon for all the facts.

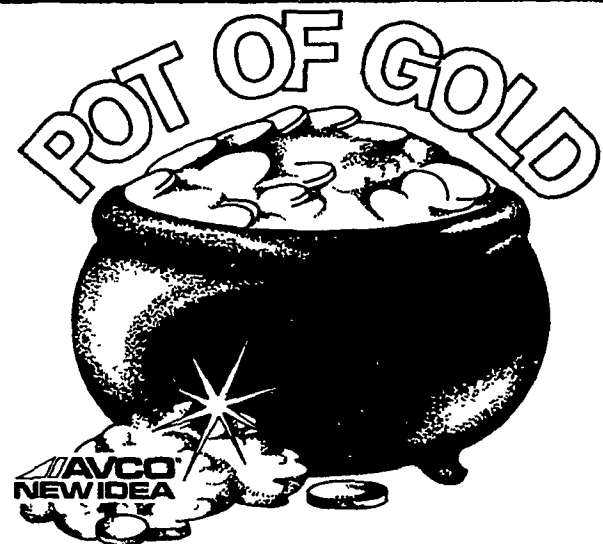

Hay & Forage

EQUIPMENT SALE

Something FREE in '83!

WIN the use of the New Idea Haytool or pull-type Forage Harvester of your choice for one year. Register to win at our Pot-of-Gold Demonstration where you'll see New Idea's hay and forage equipment in action!

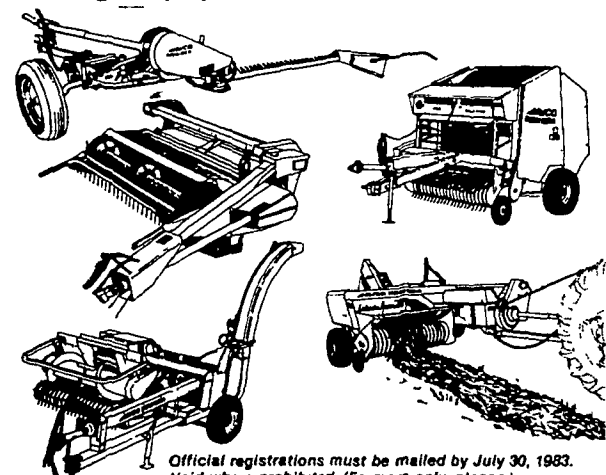

Official registrations must be mailed by July 30, 1983. Void where prohibited (Farmers only, please)

AVCO NEW IDEA

They're both doing the same thing...

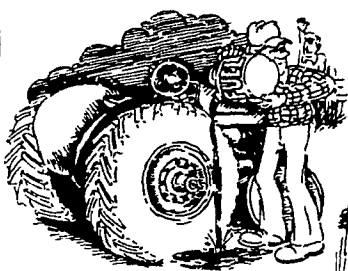

... wasting energy

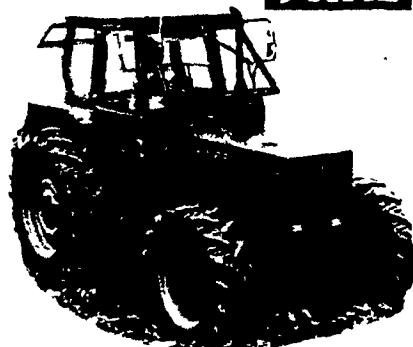
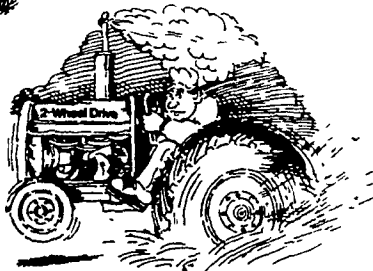

SAME

DEMONSTRATION OF SAME TRACTORS 16 HP - 160 HP

Whether you spin your wheels for lack of traction, operate tractor(s) powered with inefficient engines, or pour fuel on the ground... you're wasting fuel.

SAME is the tractor for times like these.

SAME has 4WD, a full gear range, long low design and even weight distribution for less wheel slippage, less tire wear, less soil compaction, and m-a-x-i-m-u-m traction. And **SAME** full drive is designed and engineered as an integral part of the tractor — not an add on.

SAME is powered by a fuel-efficient direct-injection air-cooled diesel engine for substantial savings on fuel, minimum maintenance costs and longer service life. (**SAME** has a limited 2-yr./3000 hrs. warranty — first in the industry.)

SAME 4WD and 2WD air-cooled diesel tractors range from 35 to 140 h.p. We are eager to show you their superior features and standard equipment, and explain the substantial savings they offer in purchase price, operation costs and maintenance costs. Stop in soon for all the eye-opening details.

Representatives From Same And New Idea Will Be Here To Answer Any Questions You Have

REFRESHMENTS

Demonstrating The Dion Forage Box And Derco Forage Wagon

HEISEY FARM EQUIPMENT, INC.

Sales, Service and Parts

(717) 865-4526 or 865-4028

• Leyland & Same Tractors • Taylorway • New Idea
• Lamborghini Crawlers • GT Dryers • Landoll • Dion

RD 1, Box 2294, Jonestown, PA 17038

Located 1/2 Mile South of Fredericksburg Off Rt. 343 in Shirksville

Business Hours: 7 A.M. to 5 P.M. Daily, Sat. till Noon, Evenings by Appt.