

Guernsey

(Continued from Page A21)

daughter Twin Brook Choice Camelia.

In Guernsey bull competition, Ohio breeders took all champion honors. Tree Pump Farm of Bellevue, Ohio earned the Grand Champion Bull banner with their senior yearling Tree Pump Fayvor Tarzan.

Amy Sherman of Sherma Farm, Bellevue, Ohio followed in the reserve slot with her Dairy Fayvor son; Sherma Fayvor, Helen Abraham.

Additional results of the National

Guernsey Show follow:

- OPEN SHOW**
Bull Calf
 1 Sherma Farm, Bellevue, OH, 2 Moo Land Acres, Orrville, OH
Jr. Yearling Bull
 1 Snider Homestead Farm, New Enterprise, 2. Green Slopes Farm, Imbler
Sr. Yearling Bull
 Tree Pump Farm, Bellevue, OH
Champion Bull
 Tree Pump Farm
Reserve Champion Bull
 Sherma Farm
Jr. Heifer Calf
 1. Hollow View Farm, Quarryville, 2 Kimberly Fleming, Hollywood, MD, 3 Littlefield Farms, Watertown, NY, 4 Twin Brook Farms, Bentleyville, 5 Green Slopes Farm
Int. Calf
 1. Hollow View Farm, 2. Wandering Brook, Tully, NY, 3 Hollow View Farm, 4 Land Of Living, Mechanicsburg, OH, 5 Littlefield Farms
Sr. Heifer Calf
 1 Green Slopes Farm, 2 Twin Brook Farms, 3.

- Holcombs Guernsey Farm, Greene, NY, 4 Hollow View Farm, 5 Ripley Farms, Cortland, NY
Jr. Yearling Heifer
 1 Hollow View Farm; 2 Land Of Living, 3 Twin Brook Farms, 4 Nelson Farm, Southington, OH, 5 Crum Elbow, Red Hook, NY
Sr. Yearling Heifer
 1 Co-Hill Farms, Scenery Hill, 2 Holcombs Guernsey Farm, 3 Bushy Park Farm, Wake, VA, 4 Ripley Farms, 5 Land Of Living
Jr. Champion Female
 Co-Hill Farms
Reserve Champion Female
 Holcombs Guernsey Farm
3 & 4 Years Old, Dry
 1 Twin Brook Farms, 2 Hollow View Farm 3 Erinwood II, Leroy, NY; 4 Snider Homestead Farm, 5 Lebanon Valley Farms, Annville
5 Years and Over, Dry
 1 Erinwood II, 2 Twin Brook Farms, 3 Anovadale Guernsey, Union Bridge, MD, 4 Green Slopes Farm
Jr. 2 Year Old
 1 Slateway Farm, Damascus, MD, 2 Holcombs Guernsey Farm, 3 Keystone Guernsey Farm, Halifax, 4 Littlefield Farms, 5 Twin Brook Farms

- Sr. 2 Year Old**
 1 Ripley Farms; 2 Middle Ground Farm, Earleville, MD, 3 Holcombs Guernsey Farm, 4 Anovadale Guernsey, 5 Littlefield Farms
PA Three Year Old Futurity
 1 and 3 Twin Brook Farms; 2 Ripley Farms
3 Year Old
 1 Crum Elbow, 2 Holcombs Guernsey Farm, 3 Twin Brook, 4 Hollow View Farm, 5 Nelsons Farm
4 Year Old
 1 and 4 and 5 Bushey Park Farm, 2 Ripley Farms, 5 Twin Brook Farms
5 Years and Over
 1 Erinwood II, 2 Tree Pump Farm, 3 Mountain Brook Farm, Taneytown, MD, 4 Holcombs Guernsey Farm, 5 Bushy Park Farm
Champion Female
 Erinwood II
Reserve Champion Female
 Bushy Park Farm
Grand Champion Female
 Erinwood II
Reserve Grand Champion Female
 Bushy Park Farm
Best Milking Female
 Twin Brook Farms
Best Three Females
 1 Twin Brook Farms, 2 Holcombs Guernsey Farm, 3 Snider Homestead Farm, 4 Ripley Farms, 5 Anovadale Guernsey
Exhibitor's Herd
 1 Twin Brook Farms, 2 Holcombs Guernsey Farm, 3 Ripley Farms, 4 Anovadale Guernsey, 5 Lebanon Valley Farms

- State Herd**
 1 NY Guernsey Breeders, Cortland, NY, 2 PA Guernsey Breeders Assoc., Lancaster, 3 OH Guernsey Breeders, Mechanicsburg, OH, 4 MD Guernsey Breeders, Union Bridge, MD
Premier Breeder
 Holcombs Guernsey Farm
Premier Exhibitor
 Twin Brook Farms
Premier Sire
 American Breeders Service, Madison, WI
JUNIOR SHOW
Jr. Heifer Calf
 1 Kimberly Fleming, 2 Green Slopes Farm, 3 Maple Point Farm, Portersville
Int. Calf
 1 Littlefield Farms, 2 Lebanon Valley Farms, 3 Long Lane Farm, Waynesboro, 4 Green Slopes Farm
Sr. Heifer Calf
 1 Kimberly Fleming, 2 and 4 Littlefield Farms, 3 Nelsons Farm
Jr. Yearling Heifer
 1 and 4 and 5 Nelsons Farm, 2 Crum Elbow, 3 Ripley Farms
Sr. Yearling Heifer
 1 Co-Hill Farms, 2 Ripley Farms, 3 Karen Lisa Davis, 4 Nelsons Farm, 5 Green Slopes Farm
Jr. Champion Female
 Co-Hill Farms
Reserve Champion Female
 Nelsons Farm
Jr. 2 Year Old
 1 Slateway Farm, 2 Maple Point Farm
 (Turn to Page A34)

EVERYDAY IS SALES DAY AT E.M. HERR'S

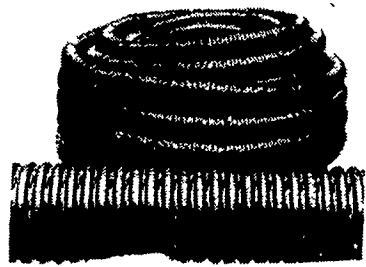

FIELD DRAIN PIPE
(ASCS Approved)

4" Solid or Perforated 6" Solid or Perforated

Also Available in 8", 10", 12", 15", 18"
CALL FOR QUANTITY PRICES

KORY GRAVITY BOX Model S-165

- Sills - 7 ga. • 165 Bu.
 - 970 lbs. • Heavy Duty
 - 60" Height
- Reg. 499.95 Sale **\$469⁹⁵**
 220 Bu. Reg. 635.95 Sale **\$599⁹⁵**

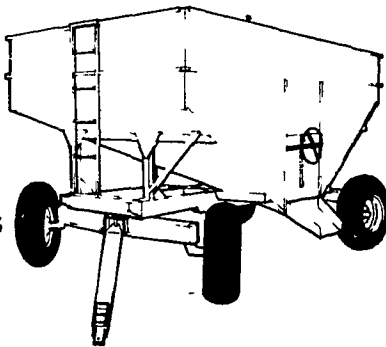

Skuttle

Electric, Portable **MOISTURE TESTER**

Reg. \$94.95

NOW **\$79⁹⁹**



RUNNING GEAR

- Standard Tongue
 - Adj. Wheel Base
 - 6 Bolt Hubs
- Less: Wagon & Tires

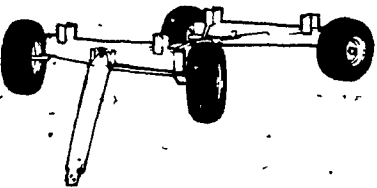

10 TON Reg. \$599.95 Sale **\$569⁹⁵**
 8 TON Reg. \$499.95 Sale **\$469⁹⁵**
 6 TON Reg. \$465.95 Sale **\$435⁹⁵**

2500 — 5000 BU. **QUICK BIN**

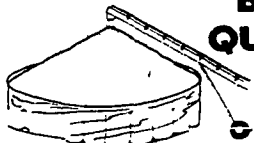

Store Your Grain For a little over **17¢** a Bu.

SPEEDY CORNCRIBS

- Easy to erect
- Rods in lead of bolts on wire mesh

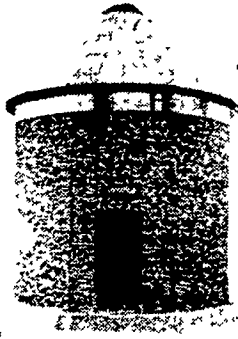

We Will **NOT BE UNDERSOLD!**
 If you find a lower advertised price on any corn crib (same capacity) we will match the price!

CORDOVAN TRACTOR BATTERIES

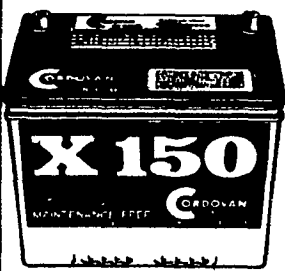

- 6 volt
- 36 mo. warranty
- w/trade-in

As Low As **\$34⁹⁵**



ASBESTOS FIBERED, 5 GALLONS, BLACK ROOF COATING

- Fills Small Cracks
 - Prevents Leaks
 - Protects Roof
 - 5 Gallon
- Reg. \$16.95 SALE **\$12⁹⁹**



ALUMINUM ROOF COATING

- Good for mobile home
 - Insulates summer & winter
 - Reduces noise
 - 5 Gallon
- Reg. \$38.95 SALE **\$33⁹⁹**

PRICES GOOD THROUGH OCT. 2

We UPS Anywhere - Just Call 717-464-3321

Or Toll Free (Area Codes 717 & 215)



1-800 732-0053

Store Hours: Mon - Thurs 7:30 A.M. - 6:00 P.M. Sat 7:30 A.M. - 5:00 P.M. Fri. 7:30 A.M. - 9:00 P.M.

50 POUND SALT BLOCKS

White **\$2.99**
 Trace Mineral **\$3.79**

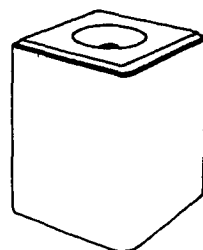

SPECIAL 80 LB. WHITE MIXING SALT
 Reg. 4.79 **\$3.99**



AUTUMN HARVEST SALE

NI 243 (250 Bu.) MANURE SPREADER
 Single Axle, Single Beater w/Used 9.00-20 Tires...

SALE PRICE **\$3550**

Optional: Hydraulic End Gate - \$670 Upper Beater - \$370



NI 243 (250 Bu.) MANURE SPREADER
 Tandem Axle, Single Beater w/New 11L-15 Tires...

SALE PRICE **\$4200**

Optional: Hydraulic End Gate - \$670 Upper Beater - \$370

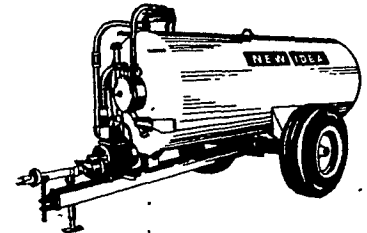

NI 1500 GALLON VACUUM TANK SPREADER
 With Rear Door

SALE PRICE **\$5395**

NI 621 (57" Fan) FORAGE BLOWER

SALE PRICE **\$1595**

NI 622 (60" Fan) FORAGE BLOWER

SALE PRICE **\$1695**

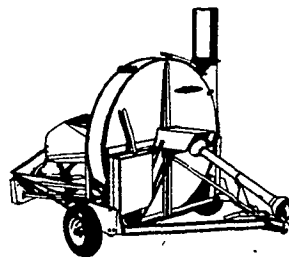

SELF PROPELLED UNI-HARVESTER!

802 Tractor, Fully Weighted, 767 Harvester, 763 (3 Row Narrow) Head...

\$50,995

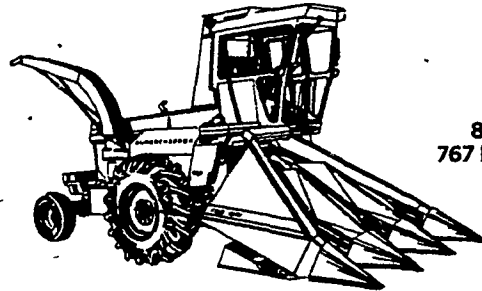

★ **NI 737 HUSKING UNIT**
 For Uni...Less Head & Feeder House SALE **\$7850**

★ **NI 844 N STRIPPER HEAD**
 4 Row, Narrow SALE **\$8950**

USED UNI EQUIPMENT...

- (1) 702 Diesel Tractor w/Weights
- (2) 702 Gas Tractors
- (1) 717 Combine (Like New) w/741 Feeder House & 713 S Grain Head
- (1), 767 Forage Harvester
- (1) 710 Combine w/711 Grain Head
- (1) 729-A Sheller
- (2) 766 Pickups
- (1) 728 Cornhead (4 Row Narrow)
- (1) 723 Cornhead (2 Row)
- (1) 729 Sheller (As Is)
- (1) 726 Sheller (As Is)

SHARTLESVILLE FARM SERVICE

RD 1, Hamburg, PA

H. Daniel Wenger, Prop.

215-488-1025