

# SPRING EQUIPMENT SPREE!

**SPERRY NEW HOLLANDS GOT THE PROGRAMS TO HELP YOU GET THE MACHINES YOU WANT**

**G  
R  
I  
N  
D  
E  
R  
M  
I  
X  
E  
R  
S  
  
L  
O  
A  
D  
E  
R  
S  
  
S  
P  
R  
E  
A  
D  
E  
R  
S**

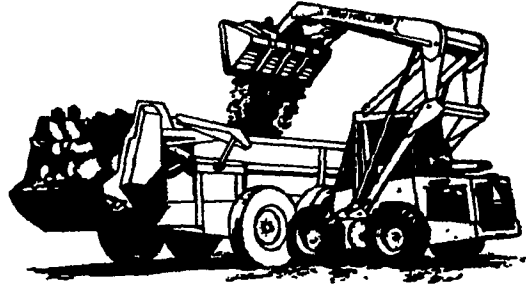

**1. SPERRY NEW HOLLAND DEALERS ARE NOW IN A POSITION TO OFFER YOU A GREAT, SPECIAL DEAL...**

**PLUS**

**2. WAIVER OF FINANCE CHARGES TO SEPTEMBER 1, 1982**

**OR**

**3. A 5% DISCOUNT BONUS ON THE AMOUNT OF CASH PAID FOR A MACHINE THAT IS NOT FINANCED**

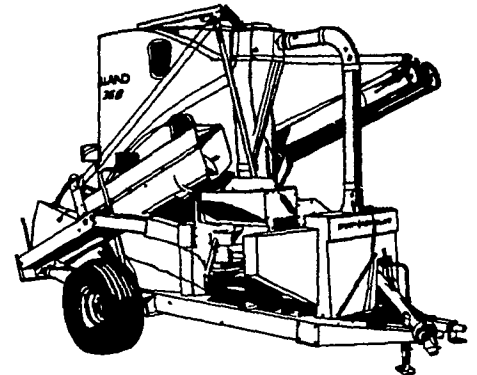

**H  
A  
Y  
&  
F  
O  
R  
A  
G  
E  
M  
A  
C  
H  
I  
N  
E  
S**

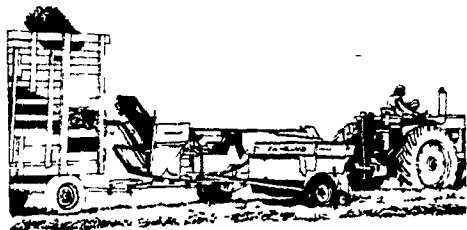
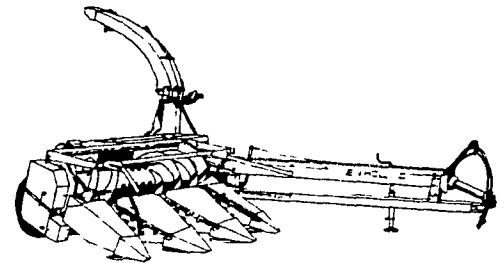
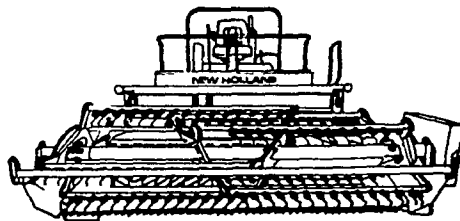
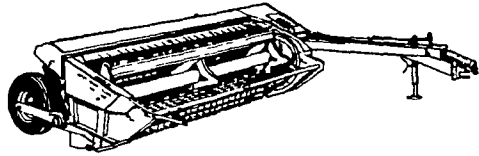

**1. DURING APRIL AND MAY WAIVER OF FINANCE IS AVAILABLE ON ALL HAY TOOLS AND FORAGE TO 10/1/82.**

**OR**

**2. GET A 6% DISCOUNT BONUS IN APRIL OR A 5% BONUS IN MAY ON AMOUNT OF CASH PAID FOR ANY MACHINE NOT FINANCED.**

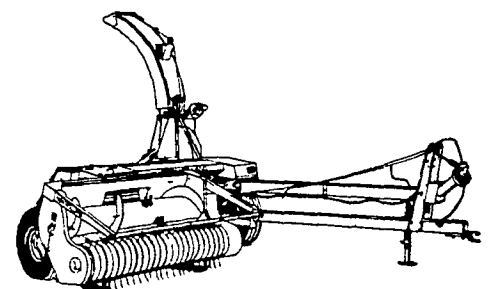
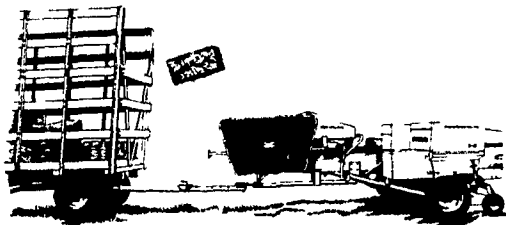
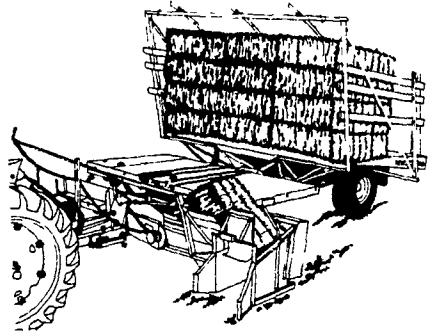

**C  
O  
M  
B  
I  
N  
E  
S**

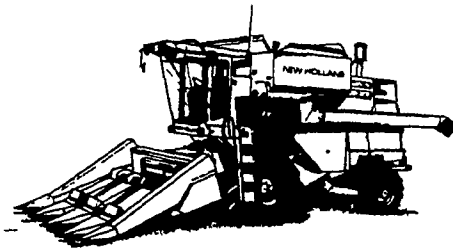

**1. DURING APRIL AND MAY WAIVER OF FINANCE IS AVAILABLE ON ALL COMBINES TO 1/1/83.**

**OR**

**2. GET AN 8% DISCOUNT BONUS IN APRIL OR A 7% BONUS IN MAY ON AMOUNT OF CASH PAID FOR ANY MACHINE NOT FINANCED**

