

# Calling All FARMERS...

GET BETTER DEPRECIATION FROM THE NEW TAX LAWS AND CASH REBATES OR FREE FINANCE FROM SPERRY NEW HOLLAND - WAIVER OF FINANCE 'TIL JUNE '82 ON HAY TOOLS, AUGUST '82 ON ALL FORAGE AND JUNE '82 (SMALL GRAIN) OR SEPTEMBER '82 ON S.P. COMBINES

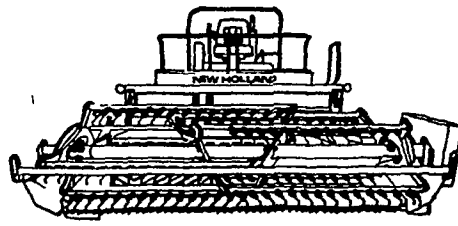

MODEL 1495  
CASH REBATE OF \$1200

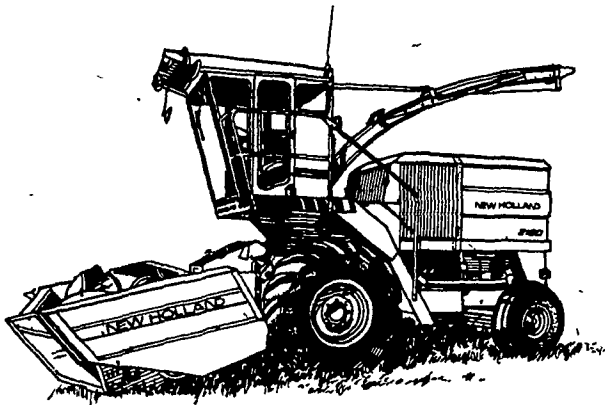
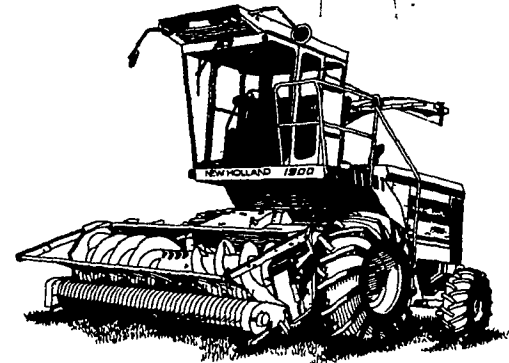

BIG REBATES ON S.P. HARVESTERS - \$3900 ON MODEL 1900 OR 2100

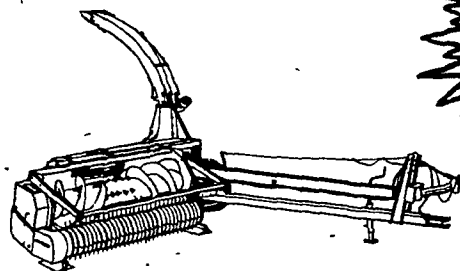
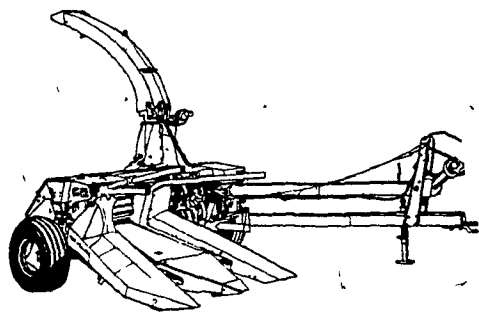

HURRY - THESE REBATES LAST UNTIL THE END OF JANUARY

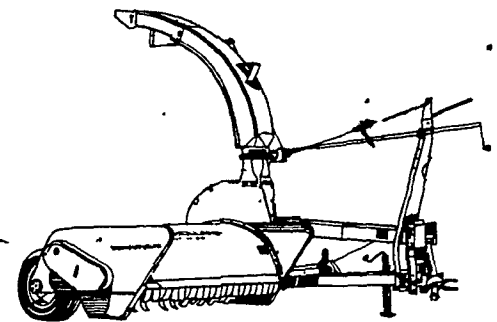

REBATES OF \$600 ON 782 AND 892 PULL TYPE HARVESTERS

REBATES OF \$200 ON FLAIL CHOPPERS, FORAGE BOXES DISC MOWERS AND MODEL 85 BALE HANDLERS

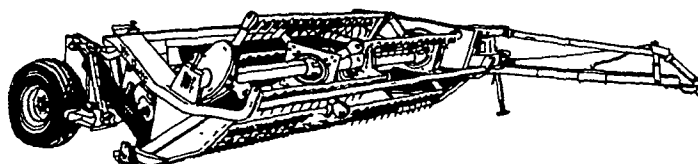
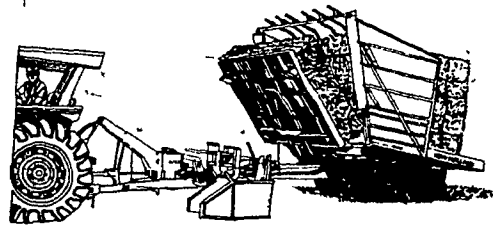

\$400 REBATE ON

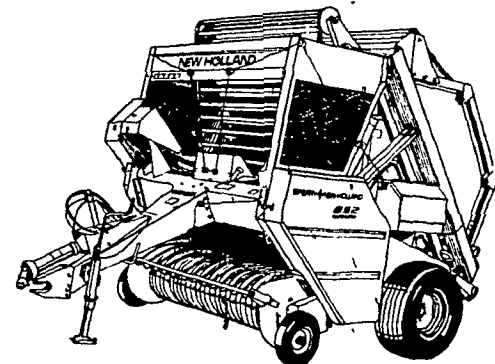

BALE WAGONS - MODELS 1002, 1003, 1036, 1037; MOWER CONDITIONER MODEL 495; ROUND BALERS MODELS 846, 847, 857, 852

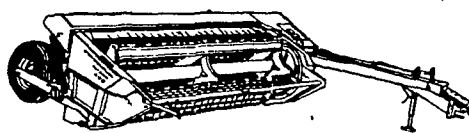
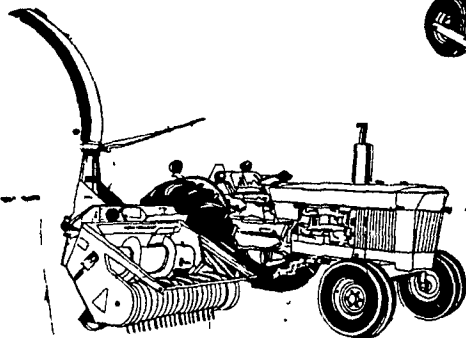
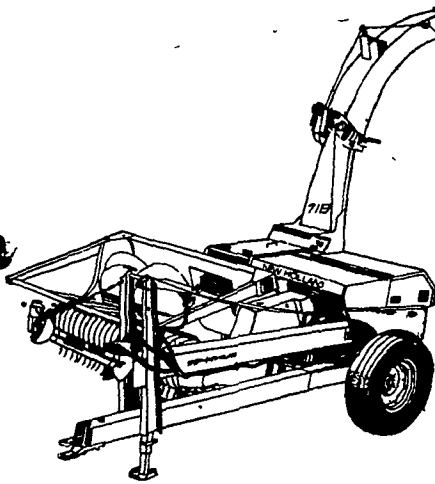

REBATES OF \$300 ON

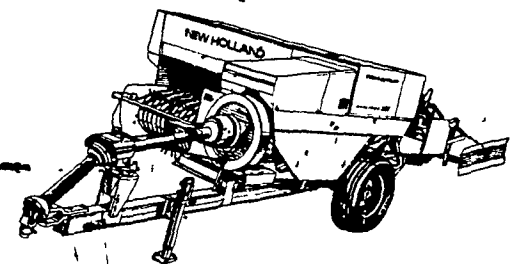

FORAGE MODELS 718, 707; MOWER CONDITIONERS MODELS 472, 474, 488, 489, AND BALERS MODELS 310, 311, 315, 320

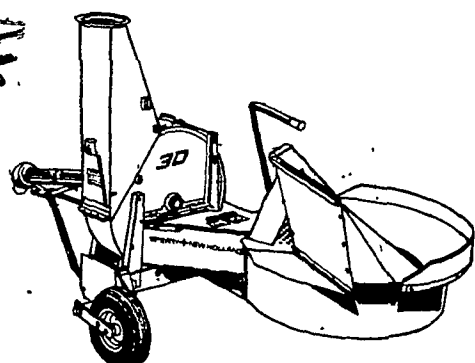
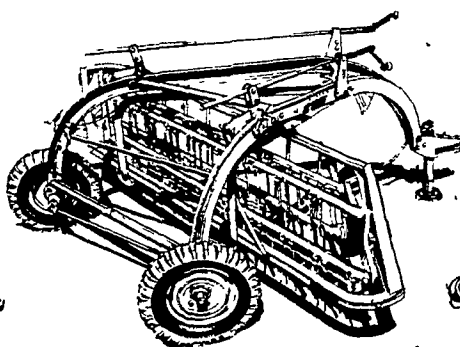

REBATES OF \$100 ON RAKES AND BLOWERS

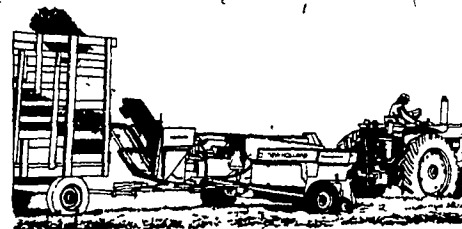

REBATES OF \$75 ON SICKLE BAR MOWERS AND BALE MOWERS

