

Calling All FARMERS...

JUST IN TIME FOR YOUR YEAR END PURCHASES!
SPERRY NEW HOLLAND HAS SPECIAL CASH REBATES
'TIL DEC. 31.
TAKE ADVANTAGE OF THESE REBATES OR FREE FINANCE:

HAYTOOLS-JUNE 82; FORAGE-AUGUST 82; COMBINES-JUNE 82 ON SMALL GRAIN; SEPT 82 ON CORN

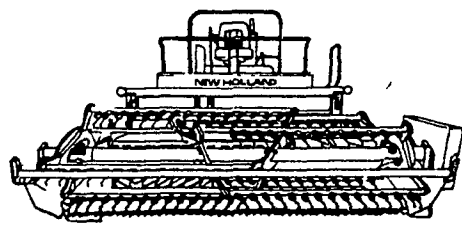
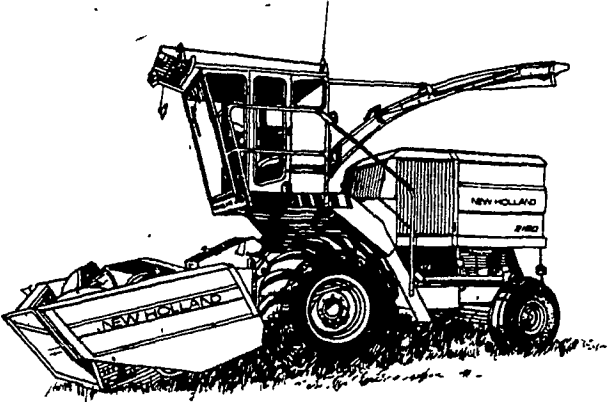

**MODEL 1495
CASH REBATE OF \$1600**

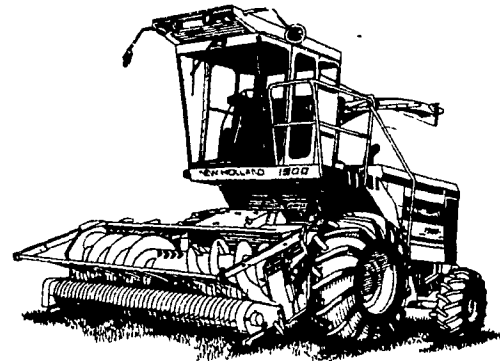

BIG REBATES ON S.P. HARVESTERS - \$5500 ON MODEL 1900 OR 2100

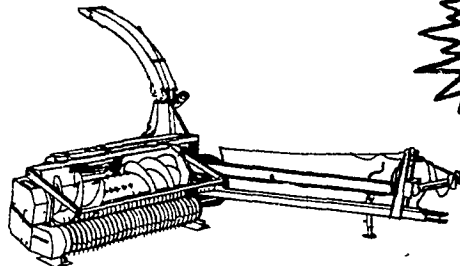
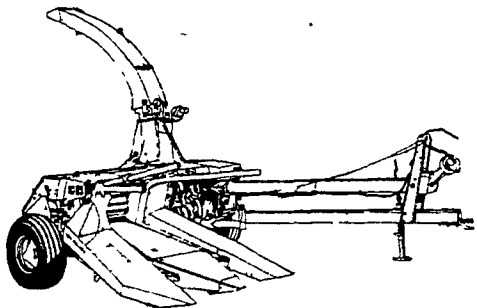

**HURRY - THESE
REBATES LAST
UNTIL THE END
OF DECEMBER**

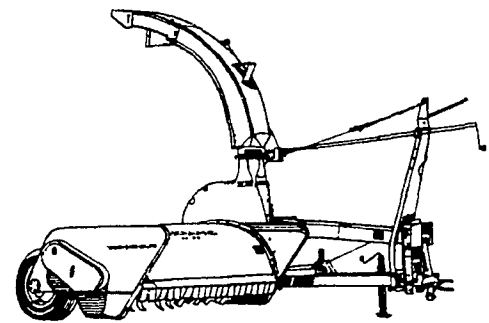

REBATES OF \$900 ON 782 AND 892 PULL TYPE HARVESTERS

**REBATES OF \$250 ON FLAIL CHOPPERS,
FORAGE BOXES DISC MOWERS AND
MODEL 85 BALE HANDLERS**

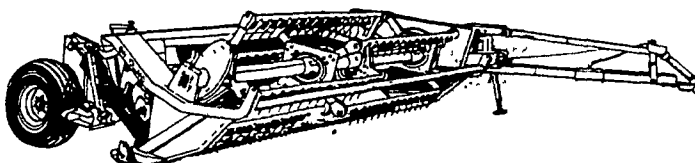
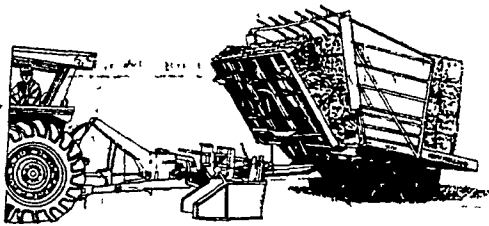

**\$600 REBATE
ON**

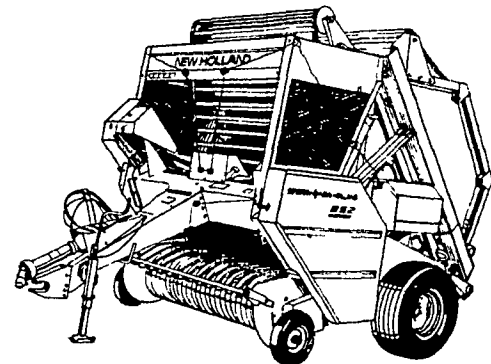

**BALE WAGONS - MODELS 1002, 1003, 1036, 1037; MOWER CONDITIONER MODEL
495; ROUND BALERS MODELS 846, 847, 857, 852**

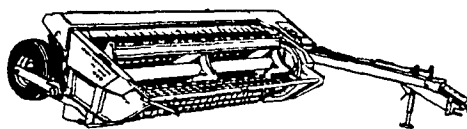
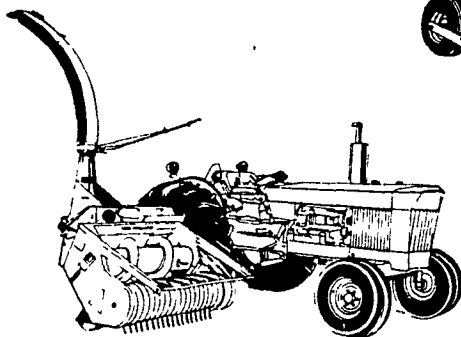
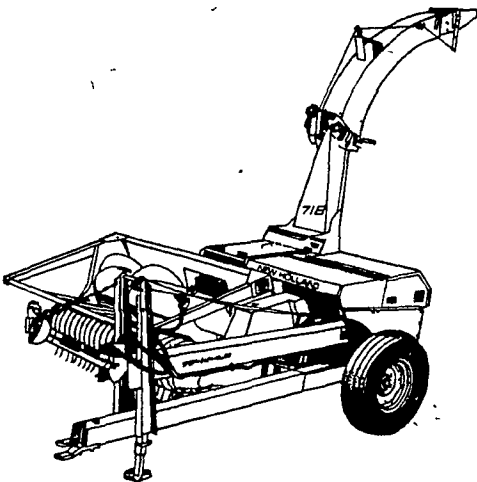

**REBATES OF
\$400
ON**

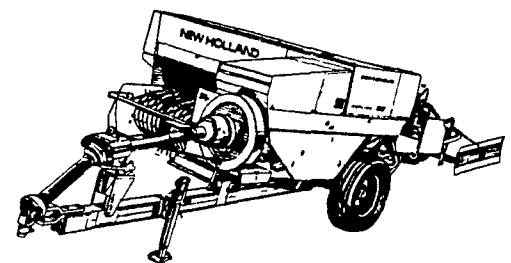

**FORAGE MODELS 718, 707; MOWER CONDITIONERS MODELS 472, 474, 488, 489,
AND BALERS MODELS 310, 311, 315, 320**

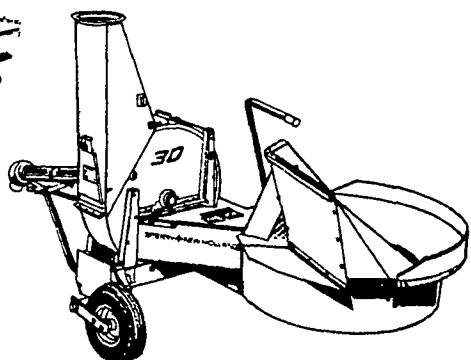
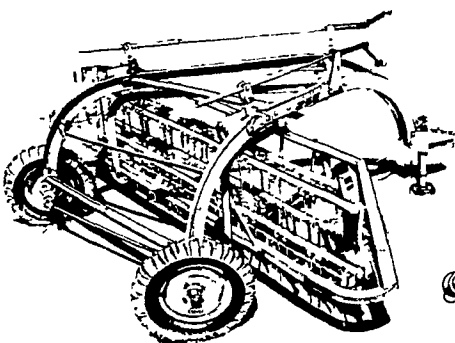

**REBATES OF \$125 ON
RAKES AND BLOWERS**

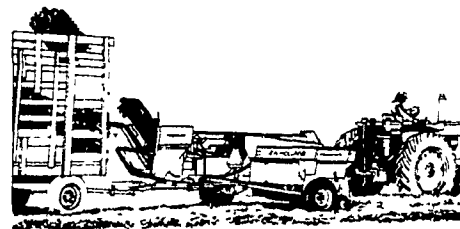

**REBATES OF \$100 ON
SICKLE BAR MOWERS
AND BALE MOWERS**

