



Calling All FARMERS...

HURRY!

**BIG CASH REBATES
LAST TIL NOV. 31!**

OR GET FREE FINANCE: HAYTOOLS-JUNE 82; FORAGE-AUGUST 82; COMBINES-JUNE 82; GRAIN-SEPT. 82 CORN

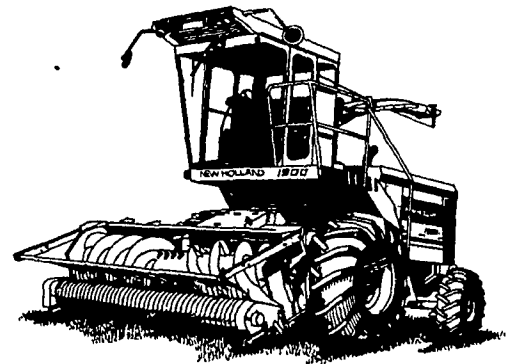
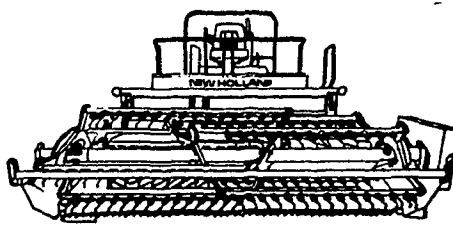
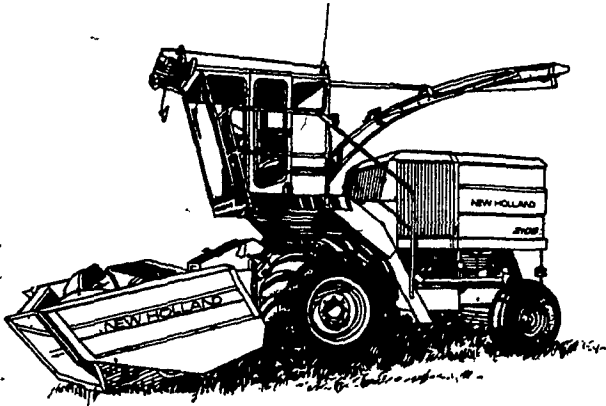

**MODEL 1495
CASH REBATE OF \$1900**

BIG REBATES ON S.P. HARVESTERS - \$6300 ON MODEL 1900 OR 2100

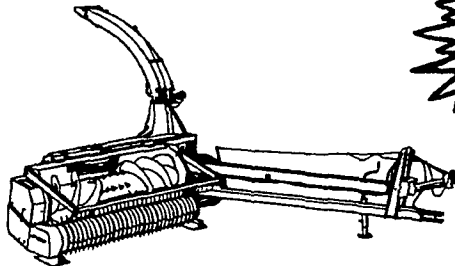
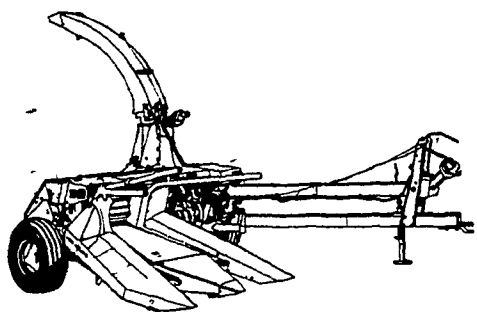

**HURRY - THESE
REBATES LAST
UNTIL THE END
OF NOVEMBER**

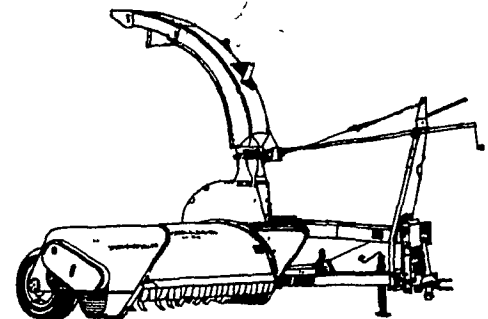

REBATES OF \$1000 ON 782 AND 892 PULL TYPE HARVESTERS

**REBATES OF \$300 ON FLAIL CHOPPERS,
FORAGE BOXES DISC MOWERS AND
MODEL 85 BALE HANDLERS**

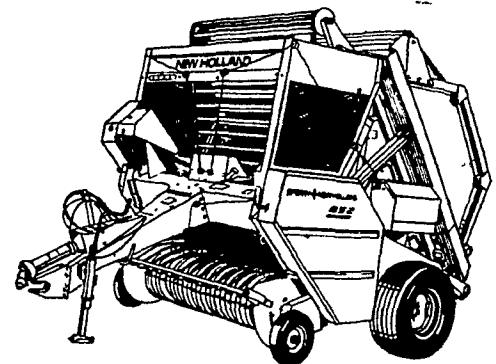
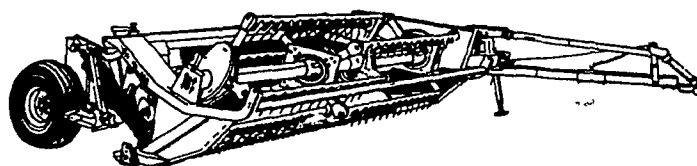
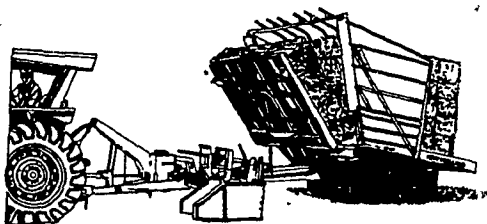

**\$700 REBATE
ON**

**BALE WAGONS - MODELS 1002, 1003, 1036, 1037; MOWER CONDITIONER MODEL
495; ROUND BALERS MODELS 846, 847, 857, 852**

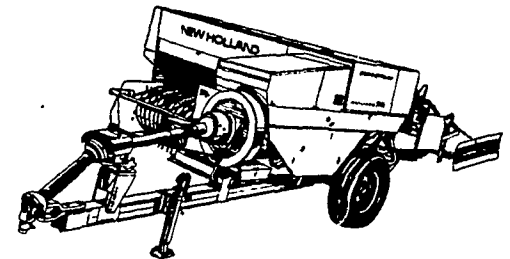
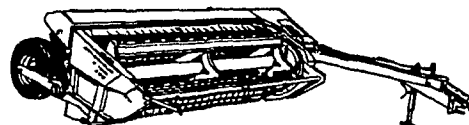
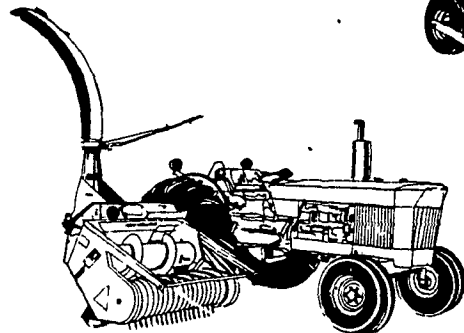
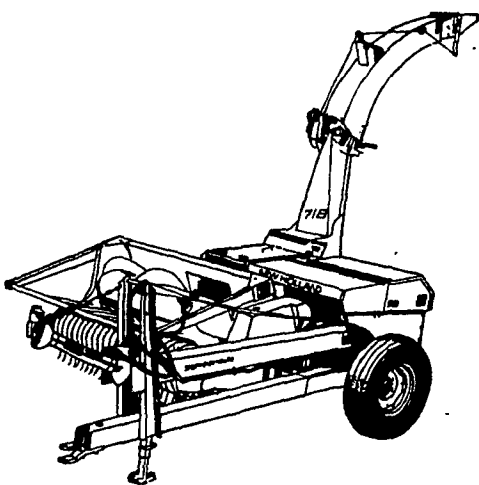

**REBATES OF
\$450
ON**

**FORAGE MODELS 718, 707; MOWER CONDITIONERS MODELS 472, 474, 488, 489,
AND BALERS MODELS 310, 311, 315, 320**

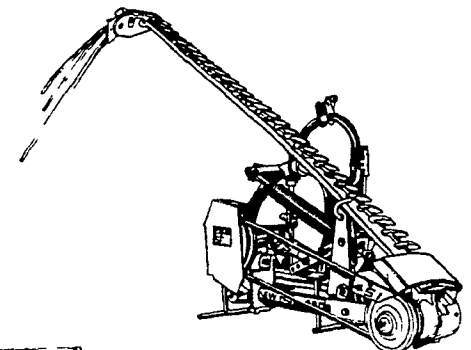
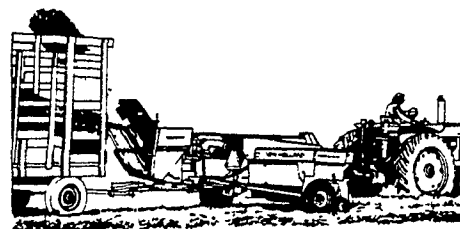
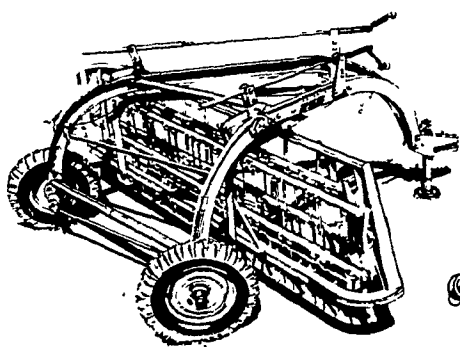

**REBATES OF \$150 ON
RAKES AND BLOWERS**

**REBATES OF \$125 ON
SICKLE BAR MOWERS
AND BALE MOWERS**

