

# SPERRY NEW HOLLAND NOW HAS CASH REBATES OR FREE FINANCE ON HAY TOOLS 'TIL JUNE 82 AND FORAGE 'TIL AUGUST 82

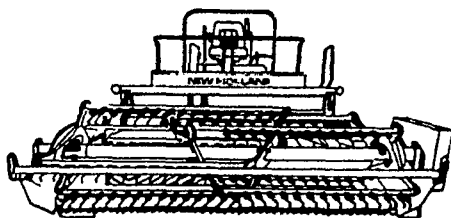

**MODEL 1495  
CASH REBATE OF '1900**

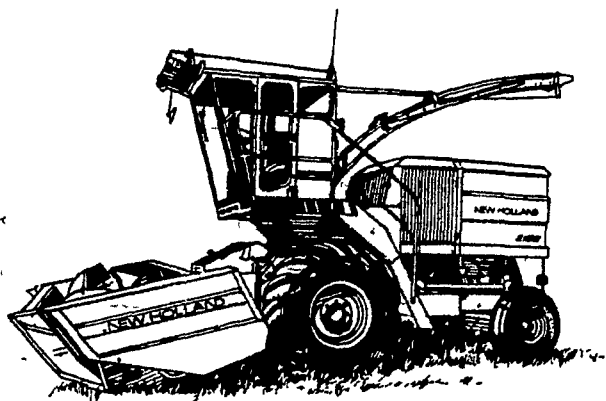

**BIG REBATES ON S.P. HARVESTERS - '6300 ON MODEL 1900 OR 2100**

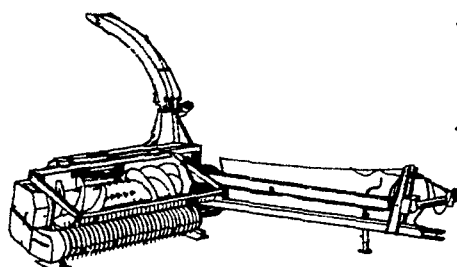
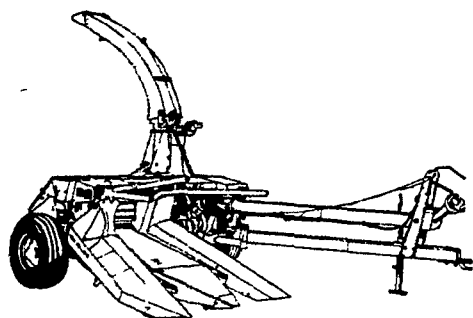

**HURRY - THESE  
REBATES LAST  
UNTIL THE END  
OF NOVEMBER**

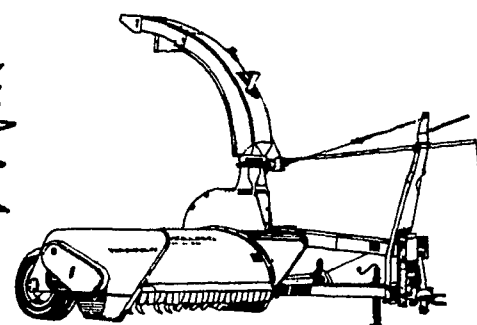

**REBATES OF '1000 ON 782 AND 892 PULL TYPE HARVESTERS**

**REBATES OF '300 ON FLAIL CHOPPERS,  
FORAGE BOXES DISC MOWERS AND  
MODEL 85 BALE HANDLERS**

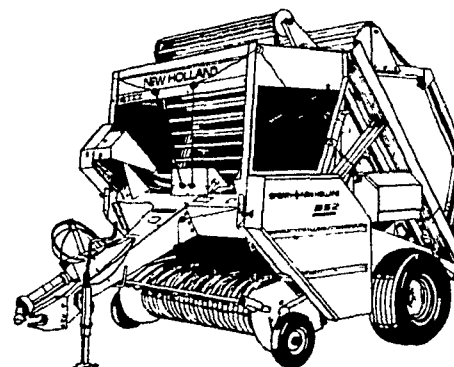
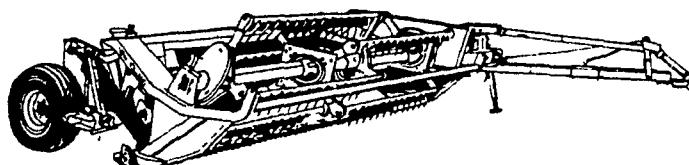
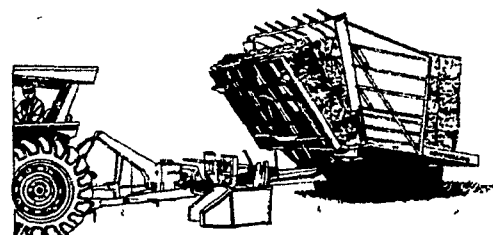

**'700 REBATE  
ON**

**BALE WAGONS - MODELS 1002, 1003, 1036, 1037; MOWER CONDITIONER MODEL  
495; ROUND BALERS MODELS 846, 847, 857, 852**

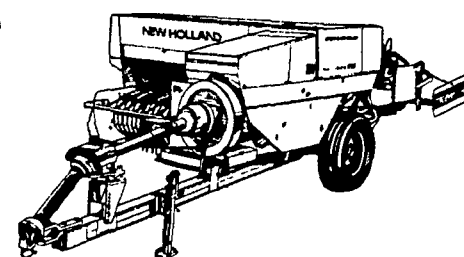
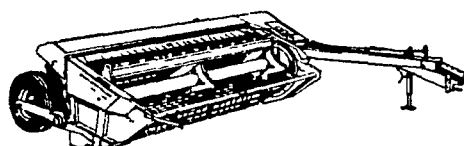
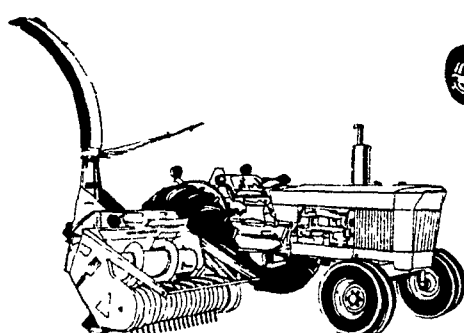
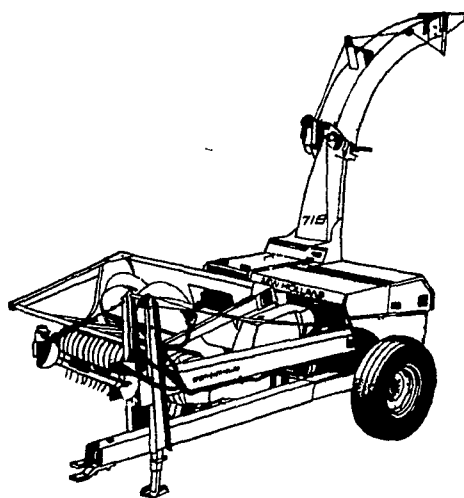

**REBATES OF  
'450  
ON**

**FORAGE MODELS 718, 707; MOWER CONDITIONERS MODELS 472, 474, 488, 489,  
AND BALERS MODELS 310, 311, 315, 320**

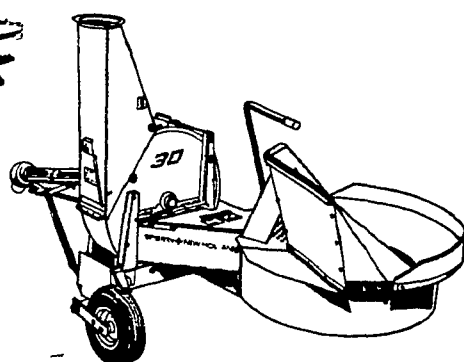
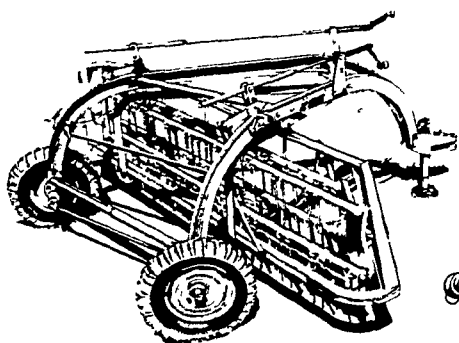

**REBATES OF '150 ON  
RAKES AND BLOWERS**

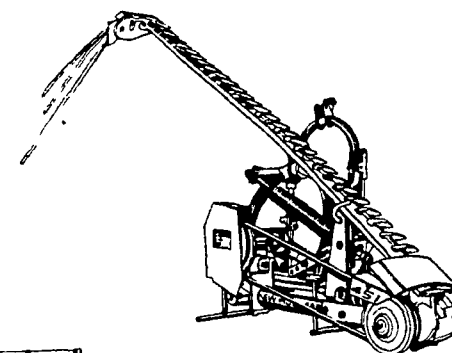
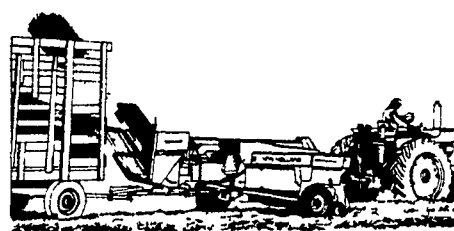

**REBATES OF '125 ON  
SICKLE BAR MOWERS  
AND BALE MOWERS**

