

FARM EQUIPMENT

FARM EQUIPMENT

FARM EQUIPMENT

FARM EQUIPMENT

Aluminum Irrigation pipe, 4000 ft. 7" x 30' sections, 300 ft. 4" x 30' sections.
1 Myers Air Blast Sprayer, 500 gal. tank. Remote control. Sprays out both sides. Needs new block. Make offer.

Robert C. Snyder Farms
R.D. #2, Northumberland, Pa.
Phone 717-473-8803 or 523-0114

705D & 708 NI Uni-harvester
731 W-4-row corn head
744 N 4-row corn head
740 feeder house
Int. 656 gas tractor, NF
717-637-2251 days
717-637-5270 nights

Lancaster Farming, Saturday, July 25, 1981—B23

FARM EQUIPMENT

FARM EQUIPMENT

FARM EQUIPMENT

SILOPRESS  **CUSTOM BAGGING**

I Am Interested In Having A Silobag Demonstration
 Corn Silage
 Haylage
 Ground Ear Corn
 Other

I Would Like Information

CHARVIN FARM
DERVIN HART
717-665-7471
R.D. #4, MANHEIM, PA. 17545

Name _____
Address _____
City _____ State _____
Zip _____ Phone _____

YOUR HARVESTING HEADQUARTERS

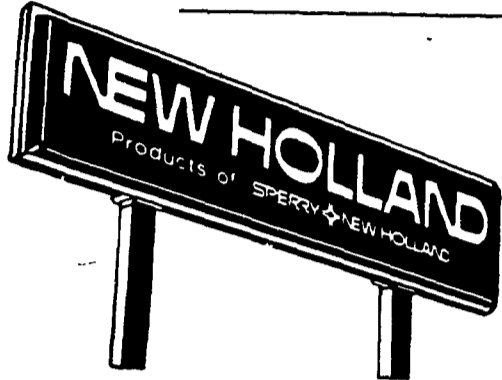

You asked for it... You got it!

A SUPER GROUP OF HARVESTERS

892 Forage Harvester

Available with 2 or 3 Row Corn Head

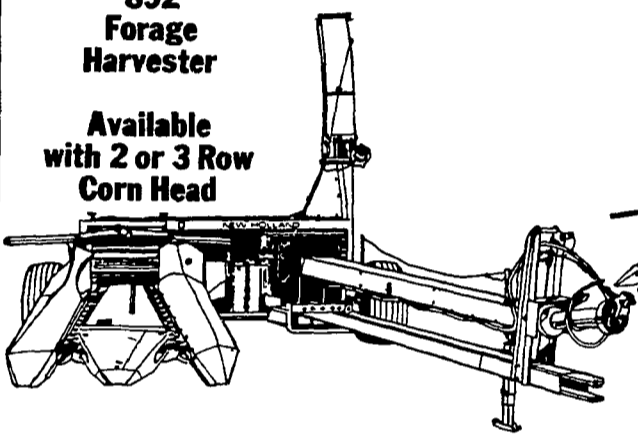

NH 1900 Forage Harvester
A New Giant, 250 H.P. Strong

782 Forage Harvester
"Most Popular in North America"

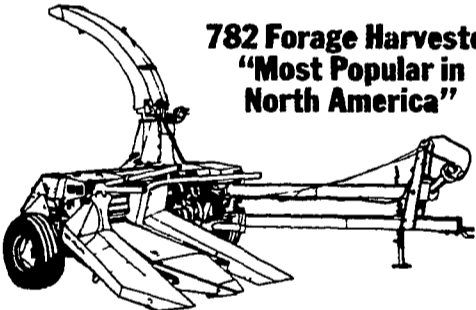

718 Forage Harvester
"The Proven Performer"

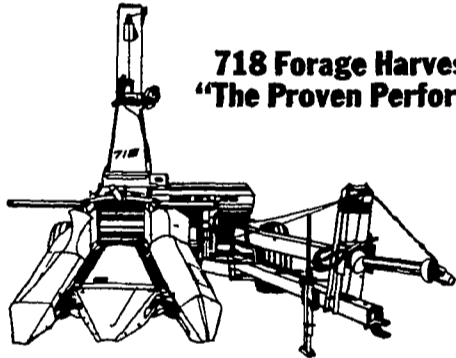

707 Forage Harvester

The Little Giant
3 Pt. Hitch
One Row with Big Capacity

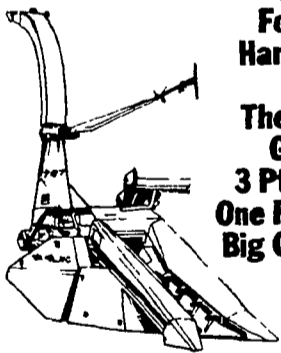

CHECK OUT THESE EXCLUSIVE FEATURES:

- Metal Detector
- Flip-Up Feed Rolls
- Under Bevel Knives (Never Requires Rebeveling)
- Uniform Cut

30 Forage Blower
High Capacity Blower

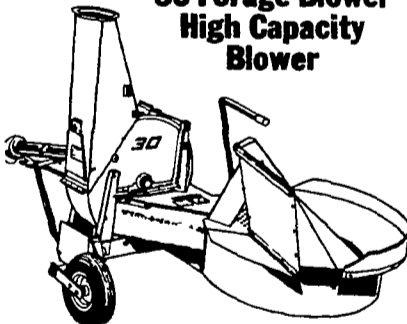

ALL THIS PLUS

WAIVER of FINANCE till JAN. 1, 1982 ON NEW & USED FORAGE EQUIPMENT ALSO INCLUDES HAY EQUIPMENT

GOOD CLEAN USED EQUIPMENT

Ford 3600 Tractor w/Cab, 80 Hours, New Cond
Farmall C w/Cultivators
Farmall 706 D, 3 Pt. Hitch, 310 Engine
Farmall M Tractor Wide Front
Oliver 77 Tractor
NH 519 Spreader
NH 510 Spreader
NH 362 Tank Spreader
NH Super 717 Harv.
NH 707 Forage Harv. 3 Pt Hitch
IH 650 Harv.
IH 56 Blower

Several Used Cub Cadets
Twin Rower to Pull 2 Rakes
IH 37 Baler w/Thwr
NH 275 Baler
NI Rake
IH 15 Hay Rake
NH 489 Haybine, Ex.
New IH 800 Planter, 6 row, Fully Equipped
NH 276 Baler
JD Model B250 18 Disk Combination Grain Drill
IH 400, 4 Row, Excellent

J.D. 494A, 4 Row
J.D. 494A, 4 Row
JD 12 Ft. Cult.-Mulcher
IH 1190 Mower Conditioner
JD 1209 Mower Conditioner
IH 7 ft. Sickle Bar Mower, Good Condition
Oliver 3 Bottom Plow
IH 531 Plow
Athens 13' Disc Harrow, Excell Cond.
Ford 8' 3 pt. Disk Harrow
Brillion Transport Spring Harrow

MESSICK FARM EQUIPMENT, INC.

RHEEMS EXIT - RT 283, ELIZABETHTOWN, PA
PHONE 717-367-1319, 653-8867

WARREN SPICKLER — HOME 653-4560 RAYMOND MILLER — HOME 653-8762

Sult's Refrigeration Service

Is Proud to Announce That
TITUS BURKHOLDER

Has Been Added To Our Sales Staff, Bringing with him 30 years of experience in Refrigeration Sales & Service

His Home Phone is 717-859-3863



SHORT ON CASH? LEASE A TANK!

Superior Cooling, automatic washing, and free hot water are only three of the reasons you should put a Mueller HiPerForm Milk Cooler to work for you!



IF SPACE IS A PROBLEM...

in your milking parlor the Model OH' can be ordered for bulkheading. A wall support channel and insulation for placing between the cooler and the channel will be provided at a nominal charge.



USED 500 GAL. SUNSET



DIESEL ENGINES

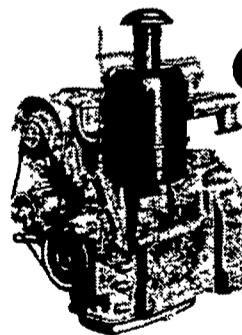

Two Cylinder Model D 302-2 14 to 32 HP

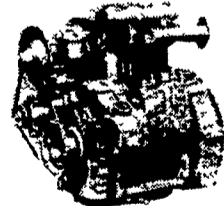

D 327 Series
Two Cylinder Model D327-2 20 to 36.5 HP Max.

For More Information Contact Your Authorized Mueller Dealer

Sult's Refrigeration Service

BEFORE YOU BUY - CHECK OUR PRICES

CLIP THIS COUPON & MAIL TO
SULT'S REFRIGERATION SERVICE
RD 1, Gordonville, PA 17529

Send More Information Have Representative Call

Name _____
Address _____
City _____
State _____ Zip _____
Phone _____

Off Rt. 340, 1 Mile East of Intercourse on Hatville Rd.
RD 1 Gordonville, PA 17529
★ 24 HOUR SERVICE
PH: 717-768-8555