

# TRI-COUNTY SWINE SYSTEMS

Let Us Help You Plan A Farrowing or Finishing Unit That is Right For You.



## SILVER LINE CONFINEMENT EQUIPMENT

★ FINISHING FENCING

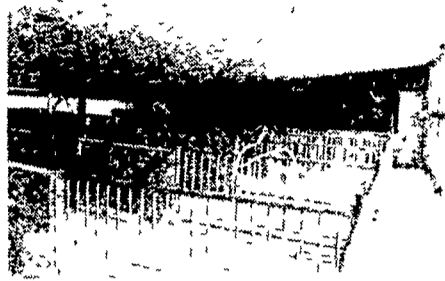

★ NURSERY CAGES

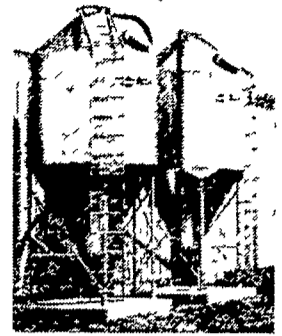

**SCHULD BINS**

**BUY BEFORE YEAR-END PRICE INCREASE COMING JAN. 1**

★ SUPPORT FRAMES (Raised Decks)

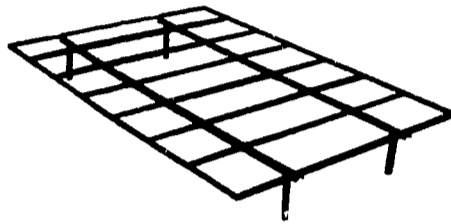

★ QUICKSIDE CRATE

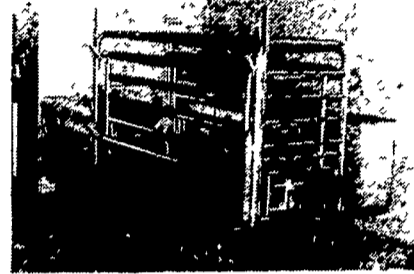

**Pax HOG & STEER FEEDERS**

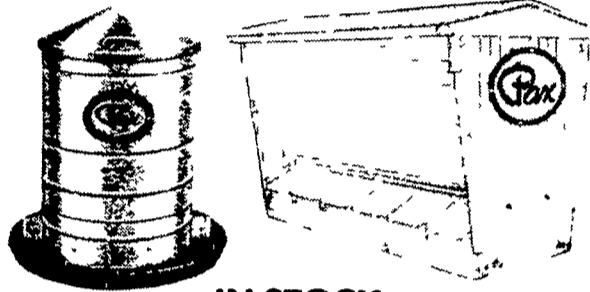

IN STOCK



3 TON TO 9 TON IN STOCK

Available in Sizes From 3 to 25 Tons

★ DEALERSHIPS AVAILABLE FOR PA AND NEIGHBORING STATES

## 'MARTIN-AIR' PATENT PENDING Fully Automatic Total Confinement Ventilation Systems

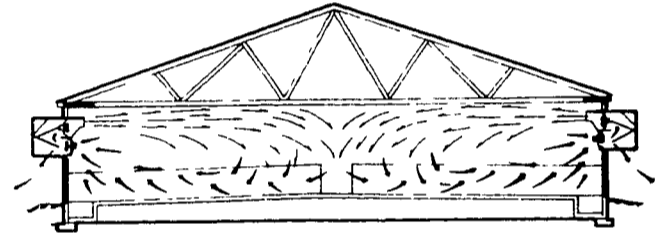
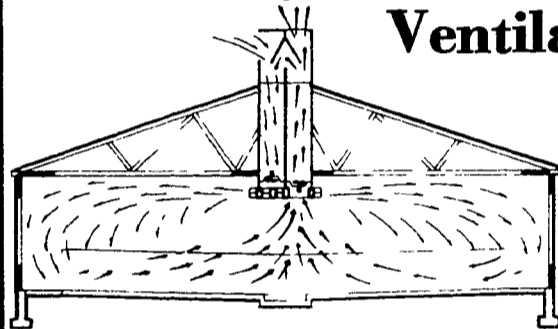

A unique air blending process provides even temperatures and controlled, draft-free air flow.

- Reduce animal stress
- End temperature fluctuations
- Reduce drug costs
- Reduce incidence of pneumonia and disease
- Reduce labor
- Lower condensation
- Confine manuring

### Why The 'Martin-air' System is best for you

The success of Martin-air systems rests on a different concept than that used by most ventilation designs. Others work by exhausting air completely then drawing cold air from outside—usually at the other end of the barn. Martin-air units use an exclusive damper system which mixes fresh air and exhaust air so the output of the unit is never more than 4°F different from the room temperature. And, at any given spot in a properly designed barn, the temperature should seldom vary more than 1°.

The Martin-air principle is simple and effective. Thermostats control fan speed and a dampered mixing chamber to blend fresh air with warm air. Constant circulation throughout the building maintains uniform temperature, eliminates drafts and reduces condensation to provide a dry environment.

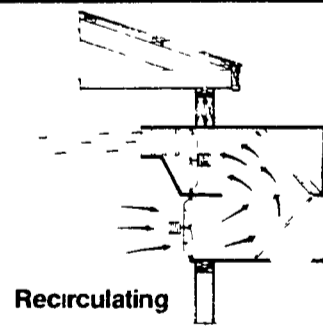
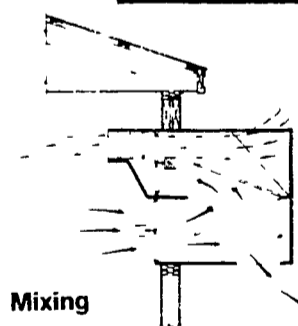
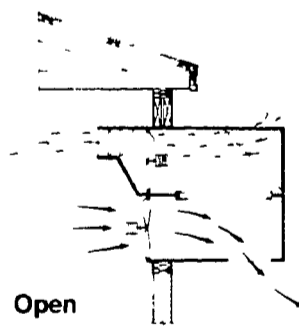

**THANK YOU... TO ALL FARMERS WHO HELPED MAKE OUR BUS TOUR A BIG SUCCESS**

### 'Martin-air' can fill your specific needs

No matter what your livestock confinement requirements, a Martin-air System can be designed and installed to fulfill your needs. Systems are designed to create a stable, draft-free environment based on building architecture, insulation, number of animals, and all heat sources. Successful installations are operating in many calf barns, dairy houses, hog, poultry and rabbit operations and even horse barns.

Martin-air units are available in a wide range of ceiling or wall-mount models and each installation is carefully designed by ventilation specialists.

Martin-air ventilation can be installed in any existing building you may be using for livestock confinement, even old bank barns.

**DISTRIBUTED BY:**

**TRI-COUNTY**

PHONE 717-274-3488 LEBANON PA.



**SWINE SYSTEMS**

**THE "SILVER LINE" -- Dependable, Up-To-Date Equipment**  
Mfg. By Tri-County Swine Systems  
**SEE OUR EQUIPMENT ON DISPLAY**  
At 608 E. EVERGREEN ROAD  
LEBANON, PA.

HOURS: Mon. - Fri. 7:00 to 4:30  
Owners; Carl Martin & Robert High

Put Your Pigs On A Blanket  
**HEAT PADS**  
FOR FARROWING CRATES AND NURSERY PENS

**GALVANIZED WOVEN WIRE FLOORING**  
Sizes in Stock: 5x7, 4x8, 3x6  
**CUSHION COATED FLOORING**  
Expanded Metal  
Sizes in stock: 5x7, 4x8, 3x6  
Woven Wire ★ LIFETIME WARRANTY  
Size in Stock: 4x8, Others Available  
**SAVE TODAY - CALL US FOR PRICES**

TRI-COUNTY SWINE SYSTEMS IS AN AUTHORIZED DISTRIBUTOR FOR THE FOLLOWING EQUIPMENT:

- Schuld Feed Bins
- AAA Inc. Ventilation Systems
- Warner Flex Augers
- Aerovent Fans
- Osteeg Hog Scales
- Woven Wire Flooring
- Cushion Coated Flooring
- Pax Equipment
- Monoflo Hog Waterers
- Lixit Hog Waterers
- Brower Equipment
- Nobbe Concrete Slats
- Magic Ray Catalytic Heaters
- Kane Feeders
- Stanfield Heating Pads