

CENTRAL FARM & FAMILY CENTER

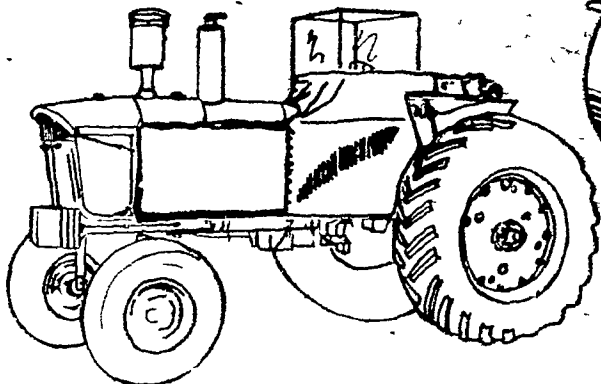

84⁹⁹

Reg 91 88 / SAVE 6 89

Universal Heater Cab

Will fit most popular models of tractors. Extra side adjustments, cut tapered to fit contour of tractor hood.

Side entry 11155-235
Rear entry 11162-235
Small models 11169-235

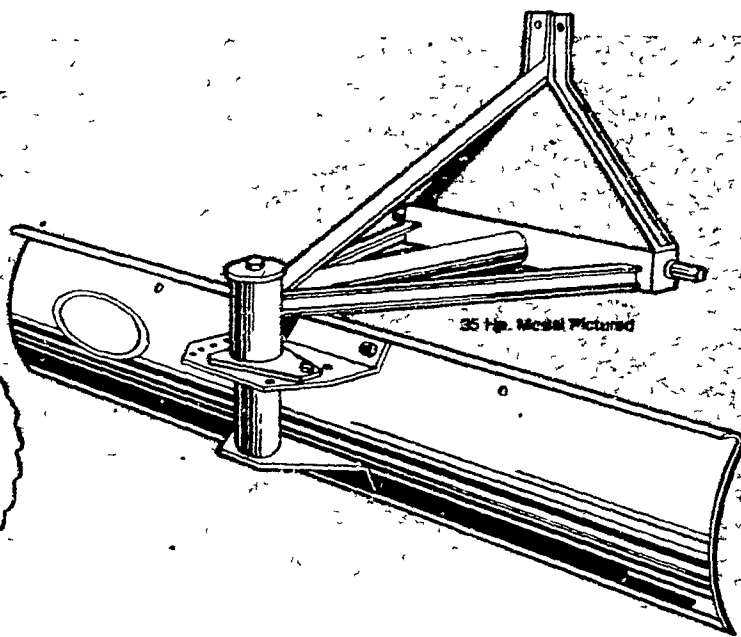

89⁹⁹

Reg 96 88 / SAVE 6 89
235 Series

Custom Fitted Heater Cabs

Heavy duty construction, equipped with full view fold down windshield. These deluxe tractor heater cabs are custom fitted to your tractor. Please specify make model and year.

**SAVE up to 40⁰⁰
Three Point Tractor Blades**

- 6' 30 Hp. Rating **129⁹⁹**
20250-157 Reg 149 99
- 6' 35 Hp. Rating **189⁹⁹**
20229-157 Reg 229 99
- 7' 35 Hp. Rating **219⁹⁹**
20225-157 Reg 259 99
- 7' 60 Hp. Rating **439⁹⁹**
20241-157 Reg 479 99
- 8' 60 Hp. Rating **479⁹⁹**
20242-157 Reg 519 99

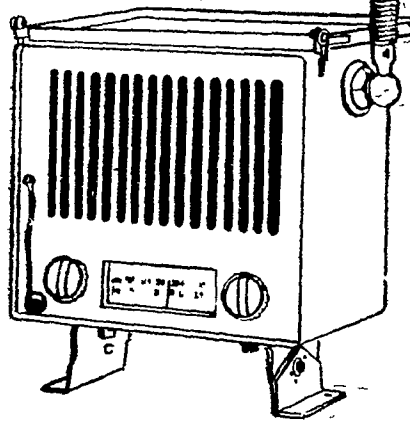

119⁹⁹

Reg 139 99 / SAVE 20 00
22090-186

AM/FM Tractor Radio

This rugged AM/FM radio has a weather-proof case designed to resist corrosion. The swivel mounting bracket allows mounting at any angle. Spring-base antenna prevents accidental breakage. Operates on 12 volt DC source only.

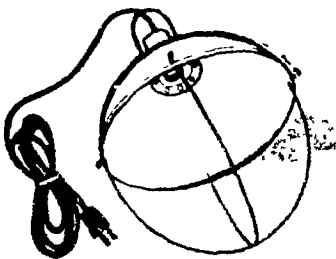

2⁹⁹

Reg 4 59 / SAVE 34%
9588-055

Hanging Brooder Lamp

Hanging reflector complete with porcelain high heat socket and wire guard for the bulb. Complete with 6-18 gauge wire and plug UL approved.

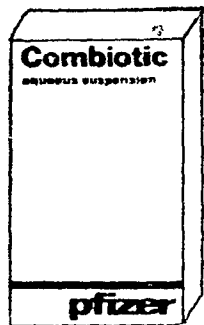

4⁷⁷

Reg 5 77 / SAVE 1 00
19008-141

Combiotic

Treats footrot, pneumonia, shipping fever, wound infections, joint infections. 100cc bottle.

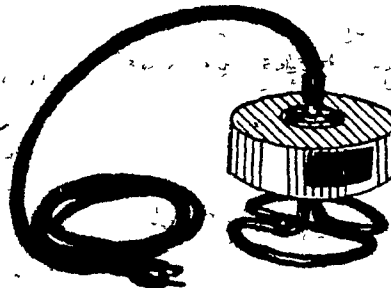

**SAVE 2⁰⁰
Floating Stock Tank De-icer**

Completely sealed terminal immersion element heats water directly. Alloy construction. Portable, just plug in the 8' power cord. Automatic thermostat control.

- 1,000 watts **20⁹⁹**
18951-144 Reg 22 99
- 1,500 watts **23⁹⁹**
18952-144 Reg 25 99

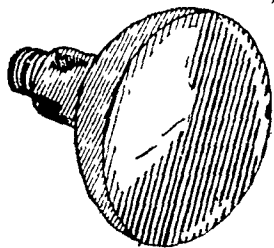

1⁴⁹

Reg 1 68 / SAVE 20%
11432-133

Clear Heat Lamp

3⁴⁷

Reg 3 97 / SAVE 12%
11433-133

Infra Red Bulb



35⁷⁷

Reg 41 77 / SAVE 6 00
22725-249

Hi-Lift Jack

7000 lbs. capacity, made of heavy duty material for long wear, 48' high with 38' continuous lift.



15⁹⁹

Reg 18 50 / SAVE 2 51
27800-285

50 Lbs. Milk Replacer

Higher quality than many milk replacers on the market. Compare for yourself and see the difference the quality can make in your animals.



TRACTOR TIRE CHAINS

Keep your tractor moving with continuous and total traction on all mud, snow and ground conditions. Unique cross chains stand up on tire lugs, are self cleaning, and won't bind. End fasteners assure easy application and removal. **Not stocked in all stores. Illustration shows field type.**

HIGHWAY TYPE	SIZE	FIELD TYPE
113.95	10x28, 11 2x28, 11x24, 12 4x24,	159.95
10612-072	9x32, 9 5x32, 10x24, 10 5x24	10601-072
169.95	12x38, 13 6x38, 12x36, 11x40, 12 4x40,	239.95
10613-072	13 6x36, 14 9x36, 11x42, 12 4x42,	10607-072
	16 4x28, 14x28	
144.95	12x28, 13 6x28, 13x26, 14 9x26,	194.95
10614-072	14 9x28, 14x24	10609-072
191.95	18 4x30, 13x38, 12x40, 13x40,	264.95
10615-072	14x34, 16 9x34, 14.9x38, 15 5x38, 15x30	10610-072
287.95	18 4x38	318.95
10694-072		10695-072
270.95		287.95
10616-072	15x34, 18 4x34 16 9x38	10611-072