

How root rots cause unseen trouble in alfalfa

LITITZ — Disease affects every crop, and many farmers might argue which crop is most susceptible to disease attacks.

Corn growers have blights to contend with, grain sorghum farmers suffer from losses caused by anthracnose and wheat producers might run into rust or wheat streak. But, a little known fact is that alfalfa and the people who produce it, may face the biggest challenge.

There are approximately 30 different diseases that quickly can slice into alfalfa yield potential. The battles that professional hay growers face during the growing season can sometimes rival the best of stories told by corn growers following the devastating 1970 blight.

The reasons not many people hear about alfalfa diseases are many. Few farmers raise alfalfa for their major income production. Therefore, there are a limited number of farmers to concern themselves and their peers with disease problems.

Alfalfa isn't produced as a commodity to be traded. So, if an alfalfa crop is wiped out, the news media as well as speculators and traders don't pick up on it.

Perhaps most importantly, only recently have more and more producers concerned themselves with measuring yield. Like a hog being shown at a county fair, alfalfa either "looks good or it doesn't." Performance was rarely measured, and farmers had no means of knowing if a crop had a 10 or 20 percent yield reduction. Fortunately, this is changing.

One of the most damaging diseases that preys upon the nation's alfalfa crop is phytophthora root rot. Root rot in alfalfa is not limited to particular regions of the country.

Phytophthora root rot does exactly what the name implies. The fungus that causes root rot likes heavy precipitation and wet or poorly drained soils, where it gets its footing and begins to rot the roots of plants. Stands of alfalfa are thinned and, of course, yield is reduced.

Alfalfa growers face an

extra challenge because phytophthora root rot cannot be controlled by any chemical means or cultural practice.

There is some good news, however. Seed companies have bred resistance into some of the varieties they now market. As awareness of alfalfa yields and the effect diseases have on those yields increases, so do the sales of these recently introduced resistant varieties.



Just one small group on the tour inspect the mechanical apparatus used by Pioneer to sort and bag their seed.

Local Pioneers

(Continued from Page B6)

Manager, York; Wilmer Nissley, Mount Joy; Edward Bilyk, R1 Belvidere, N.J.; Thomas Mrower, R1 Spring City; Henry Bundt, Lebanon, N.J.; Robert Mast, R2 Parkesburg; David Coble, R1 Hershey; Marvin Nissley, R1 Mount Joy; Scott Osborne, Powl's Feed Co., R2 Peach Bottom; Russell Sauder, N.G. Hershey & Son, Manheim; and M. Irvin Eberly, Leon Hess, R3 New Holland.

QUALITY PRODUCTS



EMHERR

EQUIPMENT, INC.

FARM & HOME SUPPLY

★ SALES — SERVICE — PARTS ★

AT LOW PRICES

CLEARANCE

Come See the Crib that
"OUTLAWS" RUST...
BEHLEN "STEEP PITCH"
CORN CRIBS

CALL FOR INFORMATION
717-464-3321

Look for a Lifetime of Rugged Service. Every Behlen Corn Crib is Hot Dip Galvanized after welding completely covering all surfaces (including weld spots) with up to 6 times the amount of zinc found on ordinary cribs.
You'll Never See a Stronger Emb. The Behlen Crib is made of No. 4-gauge Bar Mesh Steel Weathertight Steep Pitch roof fills to the peak without hand leveling. Extra wide crib doors. In sizes from 961 to 1684 bushels.

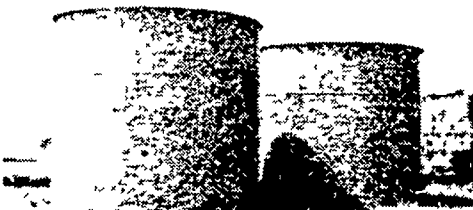

1205 Bushel Cribs On Display

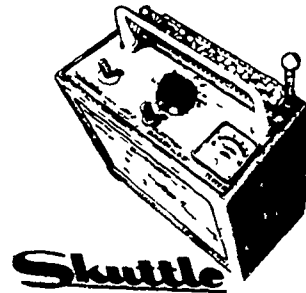

Electric, Portable
MOISTURE TESTER
Reg. \$89.99
NOW **\$69.49**

FROST PROOF HYDRANTS

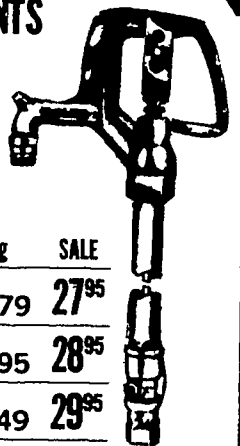

	Reg.	SALE
3'	30.79	27.95
4'	32.95	28.95
5'	34.49	29.95

5 PANEL STEEL GATES



	Reg.	SALE
10'	37.99	30.99
12'	41.99	33.99
14'	49.99	42.99
16'	54.99	46.99

PORTABLE OIL HEATERS REDDY HEATER

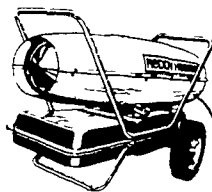

- Hi Capacity Fan
- Flame Out Safety Switch

	Reg.	SALE
30,000	139.00	109.00
50,000	169.00	139.00
100,000	265.00	229.00
150,000	329.00	289.00
350,000	799.00	699.00

MERCURY VAPOR SECURITY LIGHT

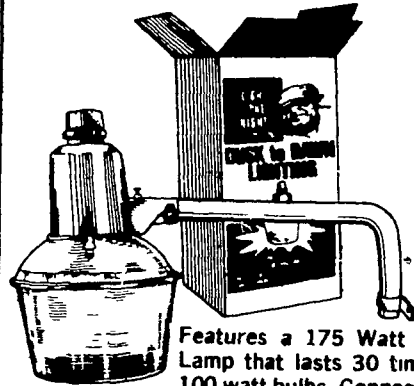

Reg. \$38.99

Features a 175 Watt Mercury Vapor Lamp that lasts 30 times longer than 100 watt bulbs. Connects to a standard 120 volt outlet and automatically turns light on at dusk, and off at dawn. No 33850

SUPER SPECIAL **\$29.99**

KORY GRAVITY BOX

- Sills - 7 ag.
- 970 lbs.
- 60" Height
- 12 ga. Steel Box
- 165 Bu.
- Reg. Price \$459.95
NOW **\$429.95**
- 220 Bu
- Reg. Price \$599.00
NOW **\$569.00**
- Less: Wagon & Tires

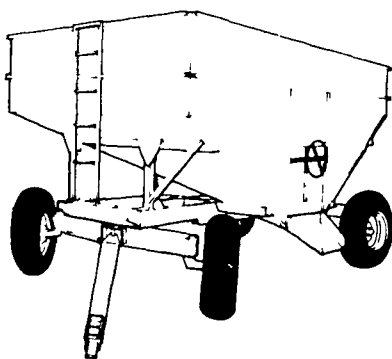

Running Gears Available - 8 & 10 Ton In Stock

R.D. 1 RTE 272 SOUTH,
HERRVILLE RD.
WILLOW STREET, PA
Phone: (717) 464-3321

Store Hours:
Mon.-Thur. 7:30 A.M. - 6:00 P.M.
Fri. 7:30 - 9:00
Sat. 7:30 A.M. - 5:00 P.M.

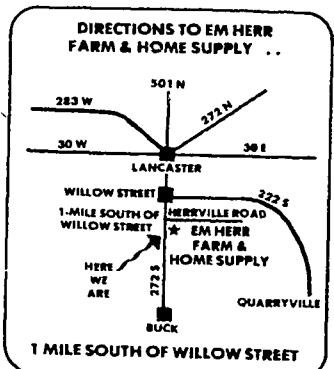

TRAILER LOAD SALE
"SPECIAL DISCOUNTS"
ON
BLACK PLASTIC SILAGE COVERS
SILO CAPS



Pit, Bunker, Trench Silos
ZIMMERMAN'S ANIMAL HEALTH SUPPLY
R4 LITITZ, PA 17543
Phone 717-733-4466