



PEANUT DAYS

SALE-A-BRATION

SALE GOOD
TILL
MARCH 22, 1980

FREE PEANUTS WHILE YOU SHOP

FARM • HOME • AUTO



SAVE \$8.04

Mercury Vapor Lamp

NOW **\$37.95** Reg. 39.99

- 175 Watt mercury vapor lamp
 - Lasts 30 times longer than 100 watt bulb
 - Connects to standard 120 volt outlet
 - Automatically turns light on at dusk, off at dawn
- 32-06710

Pickup Truck Utility/
Tool Boxes

Now **\$89** Reg. 115.00

SAVE \$26

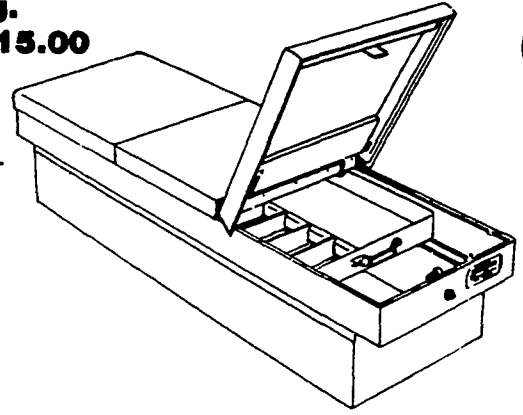

- Rattleproofed
- Rainproofed
- Dustproofed
- Heavy duty steel, 16 and 18 ga. com- to other 20 ga. boxes
- Gleaming baked white enamel weather-resisting finish
- Unobstructed rear window visibility

Overlapping Lids and Covered Continuous Hinges Rolled edges of corners are reinforced by a 5/16" rod for added strength Special Spring Steel Torsion Bar raises the lid and keeps the lid open until ready to shut A Removable Tray with handles at both ends and adjustable dividers Zinc Phosphate Undercoating and Zinc Chromate Primer adds to the Value
1-84008

SAVE \$9

Laundry Tub

Now **\$15.99** Reg. 24.99

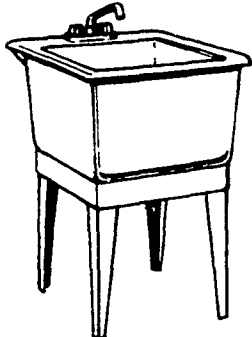

Heavy duty plastic laundry tub with stand.
31-47860

Aluminum Scoop

Now **\$12.99** Reg. 15.99

Save \$3

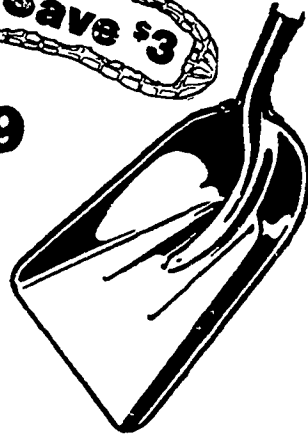

- Durable and lightweight
 - Big 15 1/4" x 19 1/4" blade
 - D Handle for easy handling
 - 27" Handle
- 44-10788

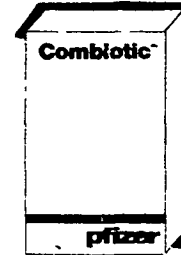

SAVE 60¢

Combiotic
Now **\$4.39** Reg. 4.99

- Fights bacteria in animals
 - An injectable suspension of penicillin and dihydrostreptomycin
 - Offers a broad spectrum of antibacterial activity
 - For use in cattle, calves, swine, sheep, horses, foals
- 22-08482-100cc

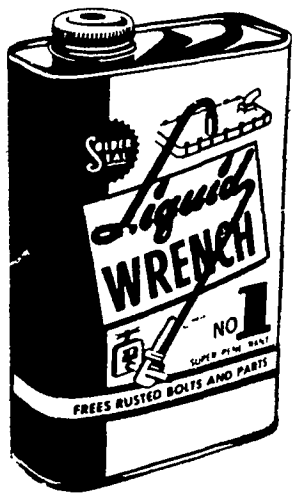

SAVE 30¢

Liquid Wrench

NOW **99¢** Reg. 1.29
16 oz.

- The super penetrant
 - Loosens rusted nuts, bolts, parts
- 1-30342



SAVE \$5.99

Simer Geyser Pump

\$39 Reg. 44.99

- Portable, submersible, centrifugal
 - Easy to install
 - 10,000 hour sealed in oil 1/2 hp motor
 - Automatic overload protection
 - Non-corrosive metal construction
- 31-24288

20% OFF All Disc Blades

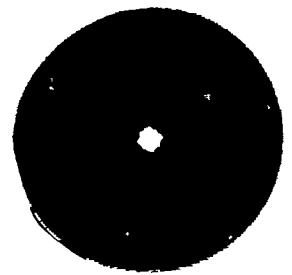

20% OFF All Rock Shares

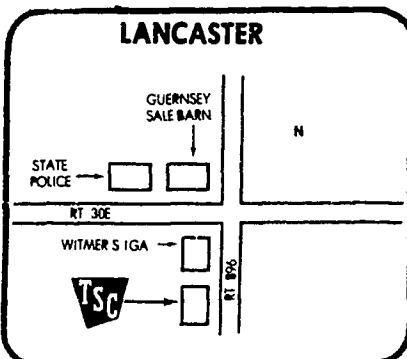

Rt. 896 South on Rt. 30 EAST
HARTMAN BRIDGE ROAD,
LANCASTER, PA 17604
717-687-7642
HOURS: Mon., Wed., Thurs. 8 to 6
Tues. & Fri 8 to 9; Sat. 8 to 5

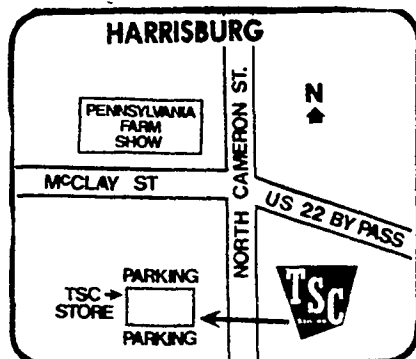

1818 N. Cameron St
Harrisburg, Pa
717-238-0436

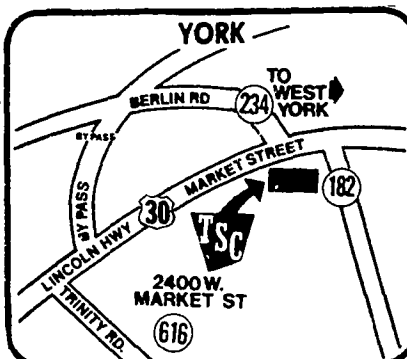

2400 W. Market St
York, Pa
717-792-0014

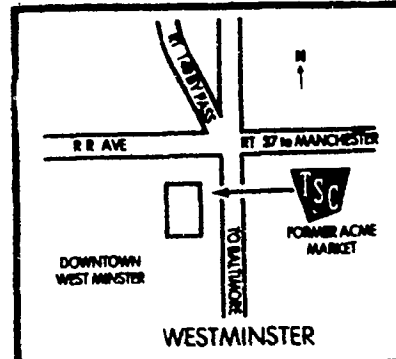

119 Railroad Ave
Hwy 27 E Manchester Rd
Westminster, Md
301-848-2060

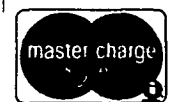

We reserve the right to limit quantities and to correct printing errors. Prices subject to stock on hand