

HARRISBURG — The Pennsylvania Association of the Future Farmers of America will hold its Winter Convention here next week.

A highlight of this annual convention is the presentation of 330 Keystone Degrees recipients

Students must have met the minimum qualifications of earning at least \$500 from their projects, demonstrated leadership by serving as a Chapter officer or committee chairman.

In addition, candidates must have previously earned the Greenhand, Chapter, and County Farmer degrees.

The Lancaster Farming staff congratulates all of the outstanding young Keystone Degree recipients, their parents, and their vocational agriculture instructors and advisors.

Lancaster County is the single county with the most Keystone Degree nominees. The Manor FFA Chapter of Penn Manor High School is the largest school represented. The Chapter has eleven members who will receive the degree.

In addition to the Keystone Degrees, special State Awards will be presented.

The 1980 Regional Star Farmers in the South Central Region is Jesse Reichard, a member of the Blue Ridge FFA Chapter, Franklin County.

Larry A Shrawder of the Kutztown FFA Chapter was chosen the Eastern Regional Star Farmer.

Arlane H Keener of the Elizabethtown has been named the Eastern Region Agribusiness winner.

Susah Kulp of the Owen J Roberts High School, Chester County, will receive the 1980 Ayrshire Breed Association Award

Following is the 1980 Keystone Degree nominees within Lancaster Farming's prime coverage area

next week. He will also be honored as the Eastern Regional Star Agri-Business winner. Both of these honors will be presented during the State FFA Convention in Harrisburg.

Arlen is the 18 year old son of Walter and Martha Keener, R1 Elizabethtown. He is employed by Penn Springs Farm, Elizabethtown, as the herdsman for the dairy operation.

Arlen has begun a high quality Holstein herd of his own.

He has shown the dairy animals at local, regional, and state shows

As a five year member of the Elizabethtown FFA Chapter, Arlen was a state winner in the project book contest, and has won numerous dairy proficiency awards.



Arlen H. Keener

Arlen served as the Chapter chaplain.

Arlen is also active in many other dairy organizations. He is president of the Lancaster County 4-H Dairy Club, a director of the Lancaster County Junior Holstein Club, a member of the Pennsylvania Holstein Association, the National Junior Holstein Association and the Elizabethtown Mennonite Youth Fellowship.



Timothy A. Gockley

TIMOTHY ALLEN GOCKLEY
Ephrata High School

The 17 year old son of Elmer and Louise Gockley, Timothy Allen Gockley is a member of Cloister FFA Chapter.

A four year member of FFA, he lives at R 1 Renholds.

(Turn to Page C30)

TRACTOR SAFETY HINT

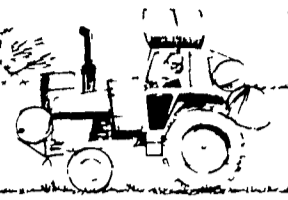

Give your tractor a brake
Always take added weight into consideration when braking. You increase stopping distance considerably when towing heavy wagons or overloading. Think liquid tire ballast wheel weights or front and rear bale carriers



SADDLE UP!
To Better Equipment... Find It In Lancaster Farming's CLASSIFIEDS!

BUILDINGS FOR EVERY NEED
Quality Built & Expertly Constructed Machinery, Confinement, Storage Compare & Then Call Us AND SAVE

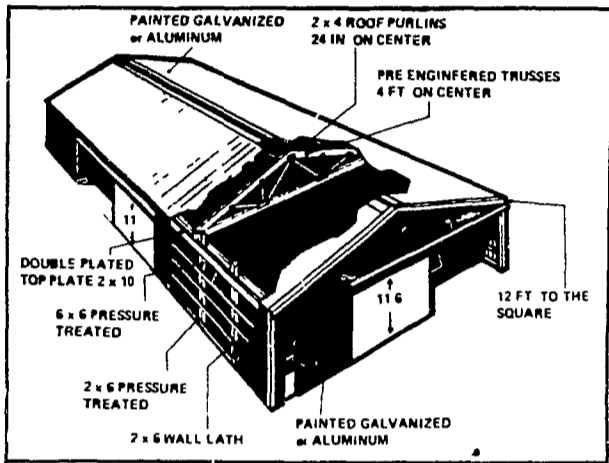

BILL & STAN INC.

RD1 Brogue, PA (717) 927-6092
Serving York, Lancaster & No. MD

Lancaster County

ARLEN H. KEENER
Elizabethtown Area High School

Arlen H. Keener will receive his Keystone Degree

LITTLE TRACTORS - MID-SIZE TRACTORS - BIGGER TRACTORS - BIG TRACTORS



Ford LT 80 (8 hp) Lawn Mower

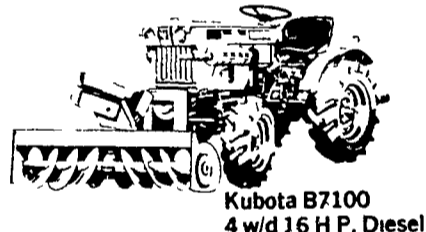

Kubota B7100 4 w/d 16 H.P. Diesel

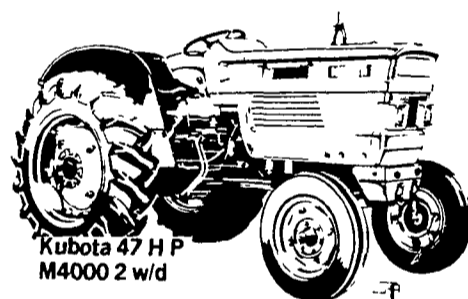

Kubota 47 H.P. M4000 2 w/d

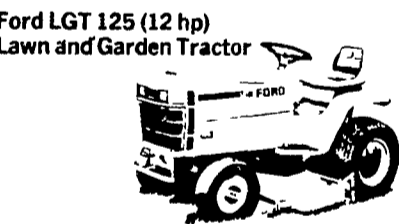

Ford LGT 125 (12 hp) Lawn and Garden Tractor

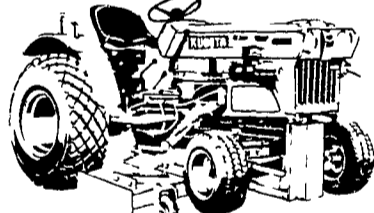

Kubota B6100 2 w/d 14 H.P. Diesel

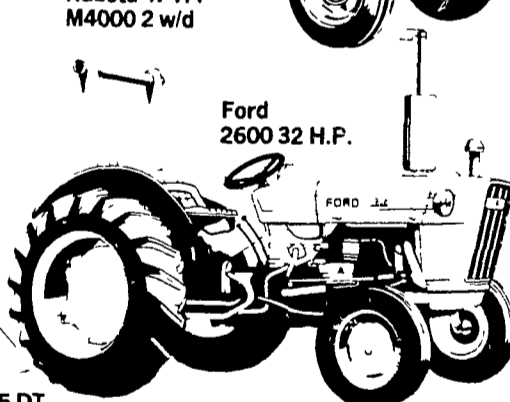

Ford 2600 32 H.P.



Ford LGT 165 (16 hp) Lawn and Garden Tractor

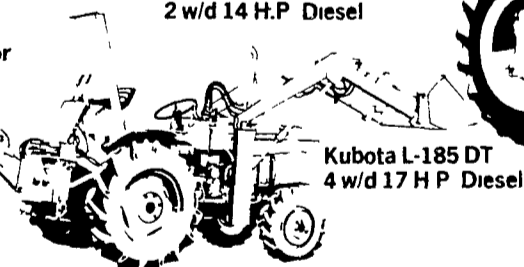

Kubota L-185 DT 4 w/d 17 H.P. Diesel

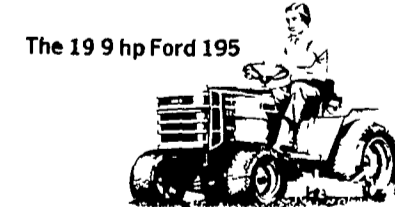

The 19 9 hp Ford 195

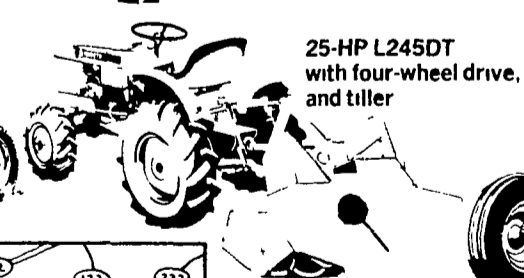

25-HP L245DT with four-wheel drive, and tiller

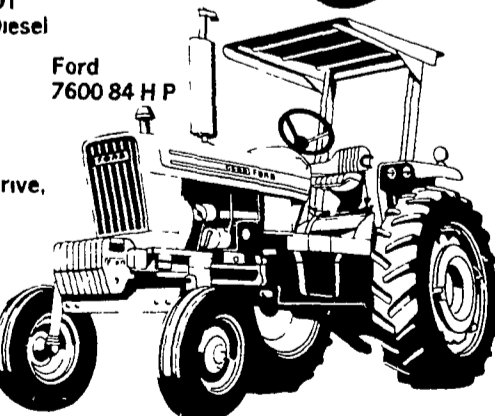

Ford 7600 84 H.P.

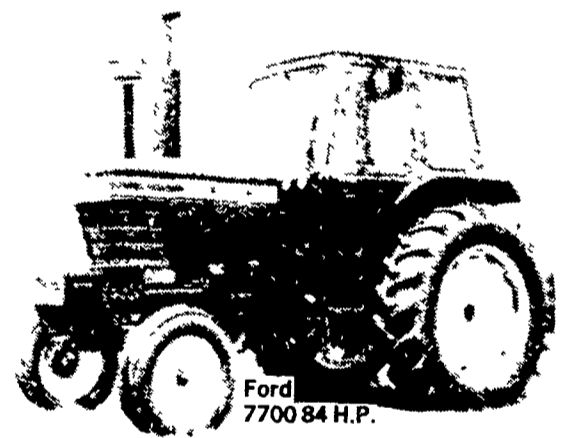

Ford 7700 84 H.P.

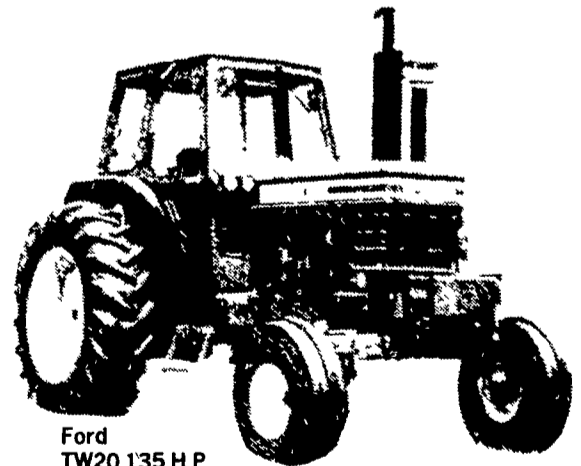

Ford TW20 135 H.P.

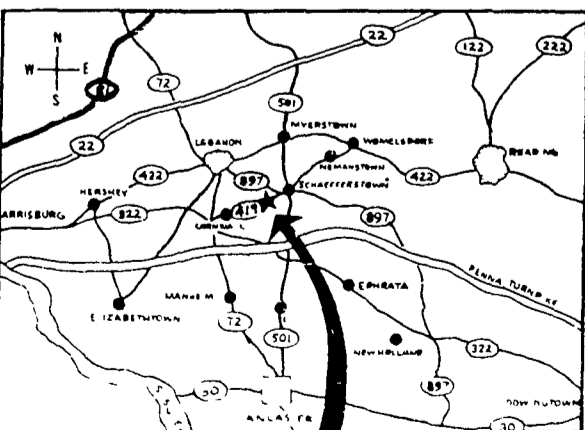

Over 60 New FORD and KUBOTA Tractors In Stock Now. Whether You're Looking For A Small 8 H.P. or 135 H.P., Gas or Diesel, 2 Wheel Drive or 4 Wheel Drive, Lawn or Gardening, Farm or Industrial, You'll Find Them All At **KELLER BROS.**

Serving The Community For Over 50 Years. STOP IN FOR A GOOD DEAL!

PARTS — SALES — SERVICE

KELLER BROS. TRACTOR CO.

Route 419 - Between Schaefferstown & Cornwall - Lebanon Co.

From Farm Show Take Route 322 East Watch For 419 Turning Left Off Of 322 Stay On 419 Through Cornwall



FREE YARDSTICKS TO CUSTOMERS MENTIONING THIS AD FARM SHOW WEEK!

717-949-6501

717-949-6501