

YOU'RE IN BARGAIN COUNTRY

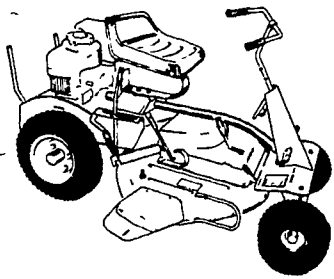

1978 SNAPPER RIDING MOWERS

8 H.P. ELECTRIC START, 30" MOWER DECK

REG. \$934.95 SPECIAL **\$829⁹⁵**



CLOSE-OUT SPECIAL GILSON RIDING MOWER

5 HP. MANUAL START, 25" MOWER DECK
 OPEN HOUSE SPECIAL **\$295⁰⁰**
 Our Reg. Low Price \$395⁰⁰

1978 BOLENS® G-11

A LOT OF TRACTOR AT A LITTLE PRICE
 w/38" MOWER DECK
 11 HP. 6 SPEED TRANS.
 Regular \$2075⁰⁰

SPECIAL **\$1649⁹⁵**

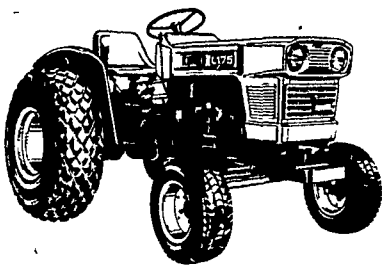
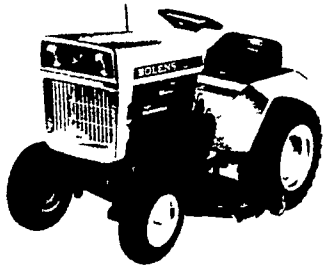

KUBOTA® TRACTORS

1977 LEFTOVER MODELS - 3 TO CHOOSE FROM

- L175 TRACTOR & LOADER..... SPECIAL **\$3925⁰⁰**
- L175 TRACTOR & 5 FT. SNOW BLADE..... SPECIAL **\$3400⁰⁰**
- L175 TRACTOR & 5 FT. ROTARY MOWER..... SPECIAL **\$3550⁰⁰**

GARDEN TRACTOR BATTERY

4522FJ 12 VOLT
 48 MONTH WARRANTY, 290 CRANKING PERFORMANCE, DRY CHARGE.
 LENGTH 9 7/16", WIDTH 6 11/16",
 HEIGHT 8 3/16"

Reg. \$43.03 SPECIAL **\$32⁹⁵**

JACKSON DUMP CART

- MODEL 100 • 10 CUBIC FT.
- UNASSEMBLED

SPECIAL **\$89⁹⁵**

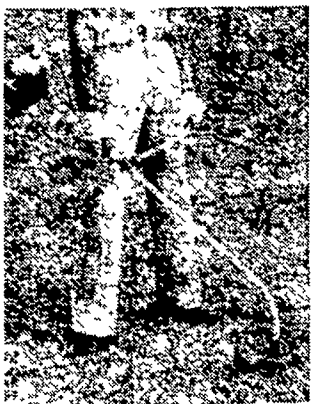

ECHO

WEED & GRASS TRIMMER
 SRM - 1400
 13.8 cc, only 11 lbs.
 OPEN HOUSE SPECIAL
\$125⁹⁵

WEED EATER GRASS TRIMMER CLIPPIE TRIMMER MODEL 307

OPEN HOUSE SPECIAL **\$17⁹⁵**

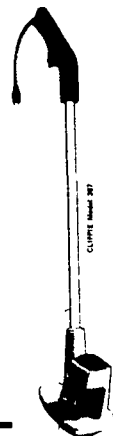

ALL OTHER GREEN MACHINE, ECHO & WEED EATER TRIMMERS

10% OFF ORIGINAL PRICE

BERLINER - Moto Guzzi Robin

Miles per gallon: 175 Horsepower: 15 Engine Size: 49 cc, air cooled Transmission: Automatic centrifugal clutch in oil bath, single speed Fuel Tank: 3/4 gallon capacity Standard Equipment Basket, rear rack, speedometer Colors: Burnt orange/white, blue

Reg. \$429.95
 OPEN HOUSE SPECIAL
\$379⁹⁵

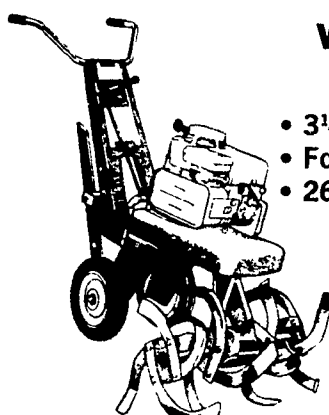
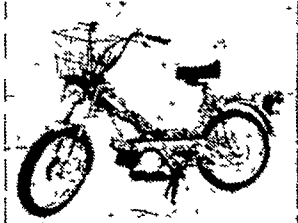

WHITE ROTARY TILLERS

- 3 1/2 HP. Gear Driven
- Forward & Reverse
- 26" Standard Cut

SPECIAL **\$195⁰⁰**
 LIMITED QUANTITY

ALL LAWN & GARDEN PARTS & ACCESSORIES

10% OFF

ALL REPLACEMENT MOWER BLADES

20% OFF

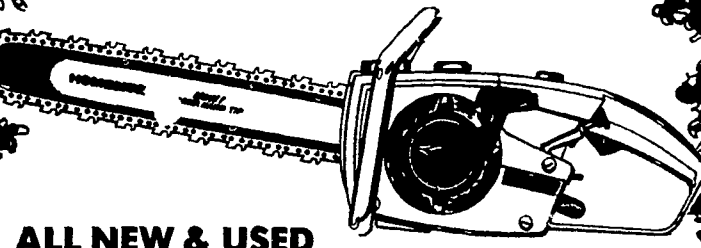

ALL NEW & USED CHAIN SAWS IN STOCK

20% OFF ORIGINAL PRICE

ECHO

CHAIN SAWS



Rugged light weight for the weekend woodsman who wants to cut like a professional
 Here's plenty of cutting muscle in a smooth running Vibe less 45cc light weight with isolation-mounted engine auto and manual oilers and comfortably grouped controls

REG. \$254.95 With 16" Bar and Chain SPECIAL **\$194⁹⁵**
SAVE \$60!

LAWN FERTILIZERS



- LAWN FOOD SPECIAL **\$4⁹⁵**
 24 - 4 - 8
 5,000 Sq. Ft.
 Reg. \$6.19
- WEED & FEED SPECIAL **\$6⁹⁵**
 25 - 3 - 7
 5,000 Sq. Ft.
 Reg. \$8.49
- GRAB GRASS CONTROL SPECIAL **\$6⁹⁵**
 5,000 Sq. Ft.
 Reg. \$8.49

FARMERSVILLE EQUIPMENT

INC.
 R.D. 4, Ephrata, Penna.
 717-354-4271