

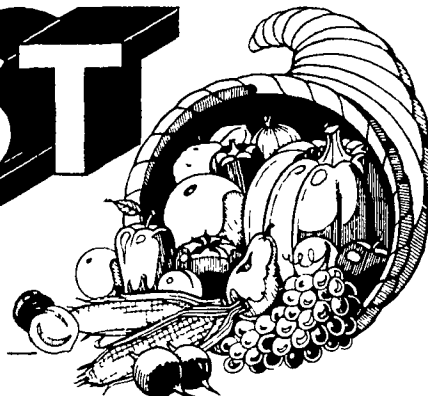

HARVEST SALE



Hurry!

Sale prices good only through Saturday, Oct. 22, 1977

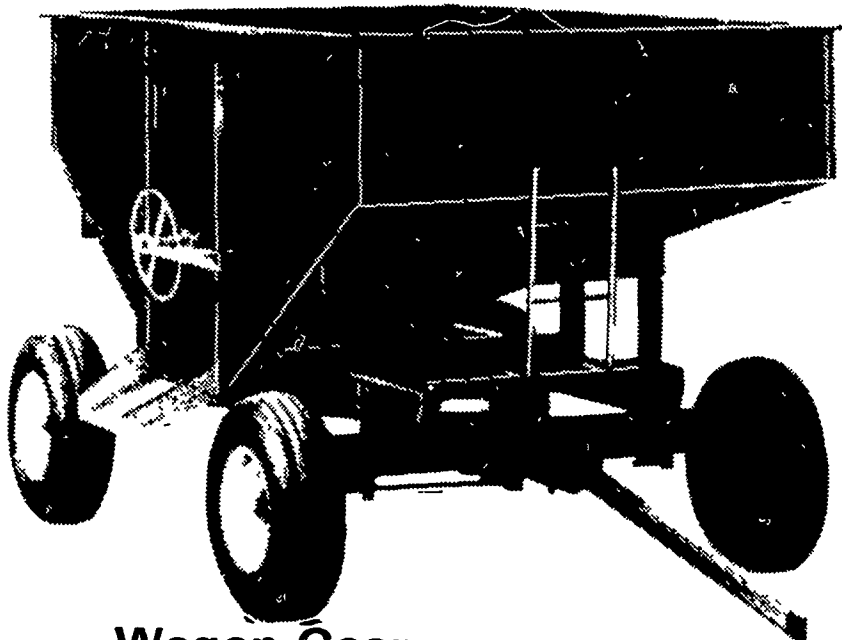

Wagon Gear

Rugged all-welded construction, heavy duty spindles, adjustable wheel base, standard tongue. All units come less tires

5 Ton SALE **209⁹⁵**
8030 046 Reg 239 95

6 Ton SALE **254⁹⁵**
8039 046 Reg 279 95

8 Ton SALE **299⁹⁵**
8045 046 Reg 329 95

10 Ton SALE **349⁹⁵**
8059 046 Reg 399 95

299⁹⁹

Plus Freight 28900-250
165 Bu. Gravity Box

399⁹⁹

Plus Freight 28901-250
Shamokin Dam Store Only
225 Bu. Gravity Box
Ends, sides and bottom are made of 14 gauge prime steel, superstructure made of formed steel plate
Wagon and tires not included

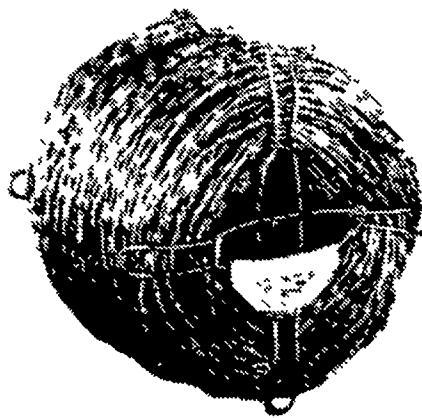

23⁹⁵

Reg 26 99 / SAVE 4 00
24672-282

4 Pt. Barb Wire
12 1/2 gauge, 4 point wire Domestic, 80 rod spools

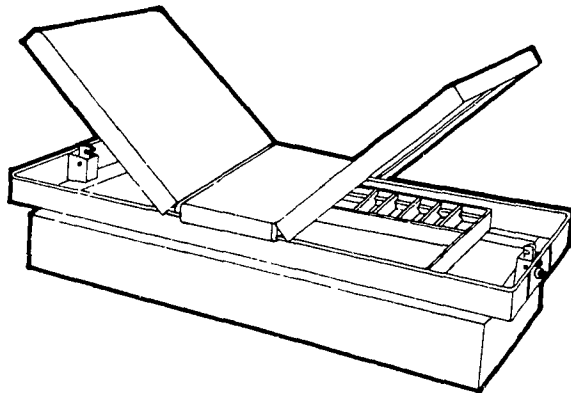

79⁹⁹

Reg. 89.99 / SAVE 10.00
22185-269

Pickup Tool Box
Fits most standard pickups Handy storage for tools Locking latches

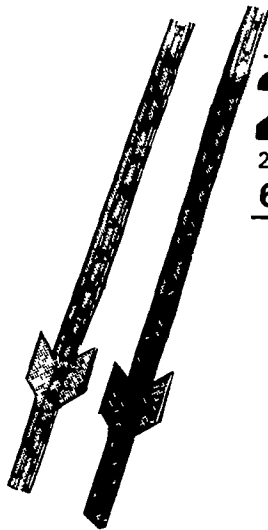

219

24677-282
6' Steel "T" Posts



2⁹⁹

18284-234
4S Brand Anti-Freeze

Same formulation as famous name brands Will mix with all ethylene-glycol base products Protects against winter freeze-ups and helps prevent summer boil-overs Guards your engine against rust and corrosion

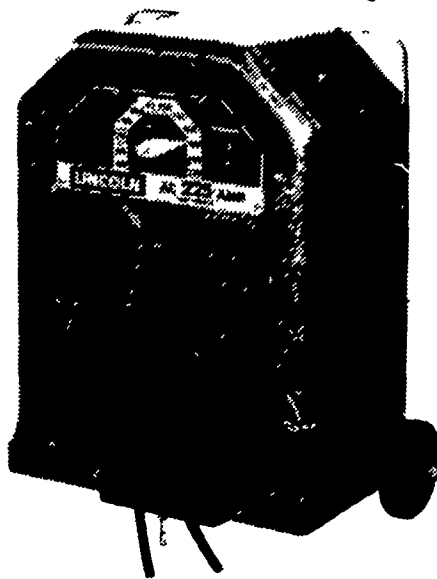

119⁹⁵

18040-115
225 Amp Arc Welder

Includes ground clamp, insulated electrode holder, 14' electrode cable, 9 ground cable, 6 input cable with plug, female receptacle and helmet Uses 220 volt, 60 cycle power source Wheels not included Regular prices may vary locally

We reserve the right to limit quantities Sale ends on above date



Booster Chargers

Solid state circuitry for dependability, high temperature copper wound transformer, full wave silicon rectifiers and a heavy duty 18 gauge steel case Comes with 8 foot grounded power cord and 6 foot output cables

100 Amp **71⁹⁹**
16280 084

200 Amp **96⁹⁹**
16281 084

229⁹⁹

Space Heater
Uses kerosene or #1 fuel oil 94 000 BTU heated air output of 350 cubic feet per minute 23985 260

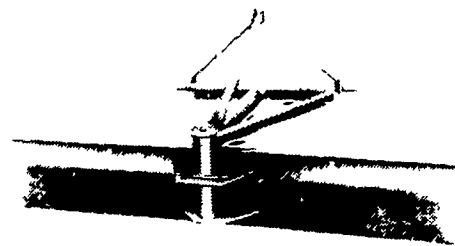
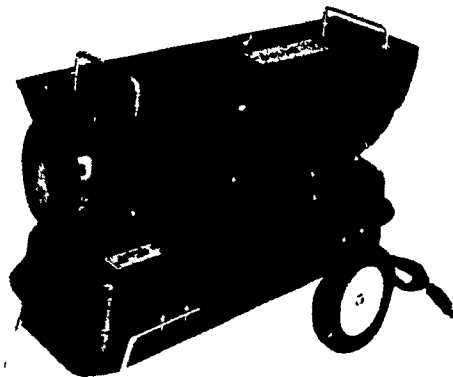

SAVE up to 60⁰⁰ Three Point Tractor Blades

6' Economy 20250-157	104⁹⁹
6' 20229-157	164⁹⁹
7' 20225-157	184⁹⁹
7' Heavy Duty 20241-157	329⁹⁹

CENTRAL TRACTOR

LANCASTER
1570 Manheim Pike
Hwy 72 North
Ph 717/569 0111
Sale Hours
8 to 5 30 Mon -Thur
8 to 8 Fri 8 to 5 Sat

CHAMBERSBURG
1351 Lincoln Way East
Ph 717/264-8282
Sale Hours
9 to 9 Mon -Fri
9 to 5 Sat

SHAMOKIN DAM
Orchard Hills Shopping Plaza
Rt 11 & 15 (former W T Grant location)
Ph 717/743-1911
Sale Hours
9 to 9 Mon -Sat