

Lowé's: the Farmers' Market

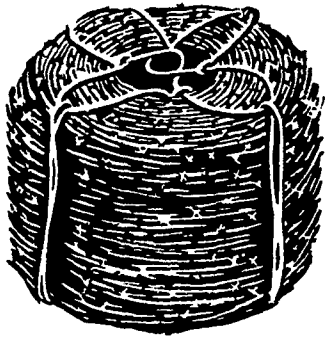

12 1/2 Gauge Barbed Wire (4 Pt.)
1320 Foot Roll
\$20.97

Our standard 4-point wire for use where a strong, heavy barbed wire fence is required. Four-pronged, sharp barbs spaced approx. 5" apart. #92054

15 1/2 Ga., 4 Pt., 1320 Ft. Roll #92050 \$22.50

OPEN LABOR DAY 8 TILL 4

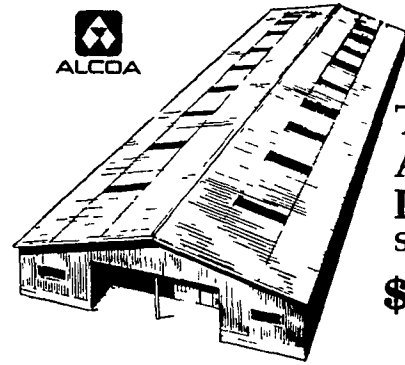

Temper Rib Aluminum Roofing
Square
\$24.88

Choose Temper Rib for your next building. Aluminum forms a strong, durable, maintenance-free roofing. Each sheet is 37 5/8" wide. #12380

5V Crimp Galvanized Roofing #12450 \$26.88

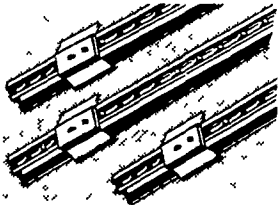

6 Foot Steel Fence Posts
\$199
Each

Rust-resistant green enamel finish. #92060



Post Hole Digger
\$11.88

9" x 5 1/2" steel blade, 6" point spread. #99762

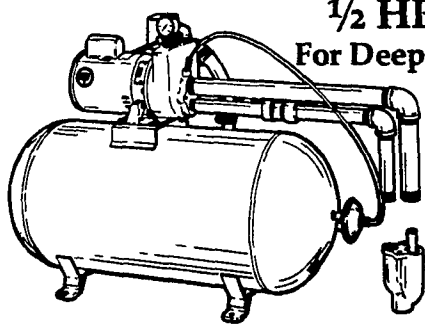

1/2 HP Water Pump For Deep or Shallow Wells

\$159.97

Includes 30 Gal. Steel Tank

Keep any area dry with this unit — or use it for irrigation, livestock watering or to supply water for the home. Capable of raising water from depths up to 120 feet with its strong half-horsepower motor. Easy to install. Ideal for compact installation. #25742

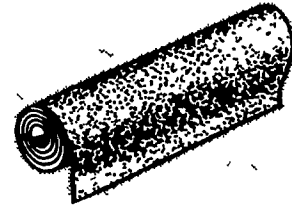

36" W. x 36" L. Roll Roofing
\$799
90 Pound Roll

Applies easily. Each roll covers 100 sq. ft. #10280



Foundation Skirting
\$3.59
Sheet

Enclose that area under your house. #60762.

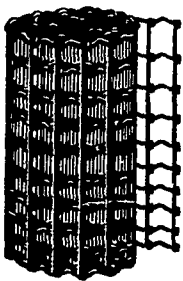

32" x 330' 12 1/2 Gauge Farm Field Fencing
\$46.88
Roll

Just the thing to enclose small animals, a garden or a yard. Features 6' stays. Has close mesh. #92264

39" x 330' Field #92266\$52.88
47" x 330' Field Fence #92268\$56.88



\$26.88
8 ft. Steel Gate

Strength and durability in an economical five-panel gate. Four-point riveting for no-sag performance. No. 92213



66" Metal Kitchen Cabinet Sink, Faucet & Strainer
As handsome as it is useful! Measures 66" wide, 36" high and 25" deep. Six storage drawers, plastic coating. #26108



Barn And Fence Paint
Usually \$8.99
Save \$2.00
\$6.99
Gallon

Brighten up and protect those exposed surfaces with a coat of our famous Enterprise paint. Designed especially for outside use. White. #48710
We Carry A Complete Line Of Paint

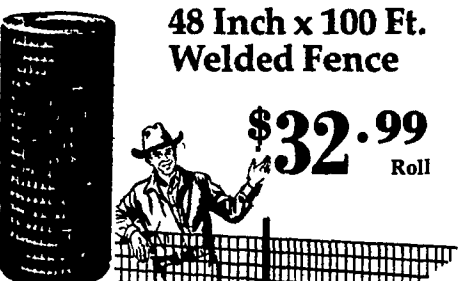

48 Inch x 100 Ft. Welded Fence

\$32.99
Roll

Close mesh gives added protection. And it's welded at each cross-joint for further strength. Made of heavy-duty 12 1/2-gauge wire. #92280

60" x 100', Welded Fence #92285 ..\$47.88

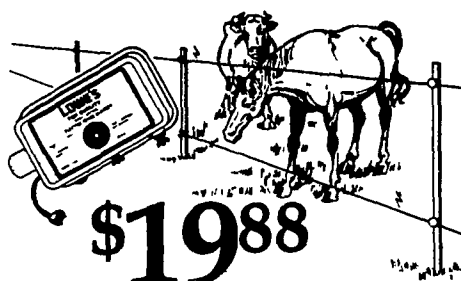

Electric Fence Charger

An economical "weed burner" type of controller. Operates on 110-volt 60-cycle AC. #92224

1/4 Mile Electric Fence Wire #92230 ..\$6.79

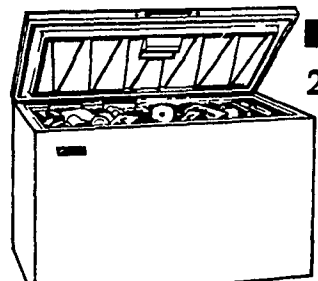

20 Cu. Ft. Chest Freezer
\$299.00

Trim grocery bills with the help of this chest-type freezer. Features adjustable temperature control inside freezer (a tamper-proof location), an exterior drain tube, security lock and two convenient sliding baskets. #50809

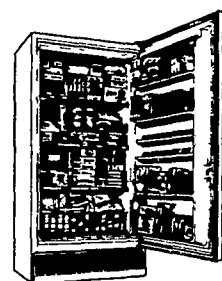

Whirlpool
15.8 Cu. Ft. Upright Freezer
\$319.76

Here's a handsome freezer with full features and an economy pricetag. Fast-freeze shelves have the cold coils right in the shelves. And super storage door puts up to 70 packages at your fingertips. Slide-out basket #50888

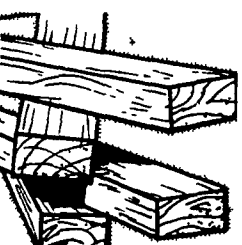

Dale Bunyan 2 x 4 Studs

69¢
Each

An economy stud, suitable for many uses. Pre-cut to standard sizes. #07002

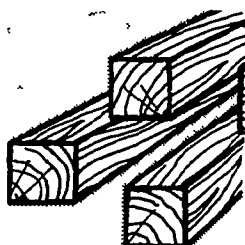

4" x 4" x 8' Lumber

\$5.99
Each

A heavy-duty support lumber. Available in 8' lengths. #04001

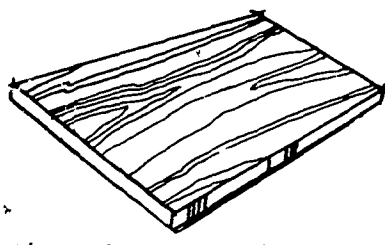

1/2 Inch, CDX Plywood

\$9.49
4' x 8' Sheet

Countless uses for this versatile wood: paneling, dog houses, you name it. 1/2" thick, four-ply layered pine. #12247

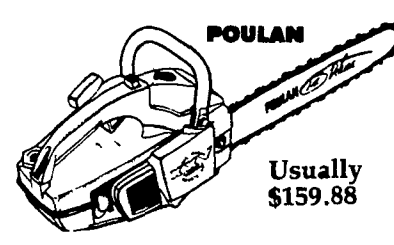

14 Inch Chain Saw

\$148.88
SAVE \$11.00

Light — yet with enough muscle to chew through most jobs in a hurry. Bar length is 14 inches, cutting capacity 24". #91625



Single Edge Wood Axe

\$8.88

Heavy-duty steel blade keeps sharp cutting edge. Tapered handle. #99783

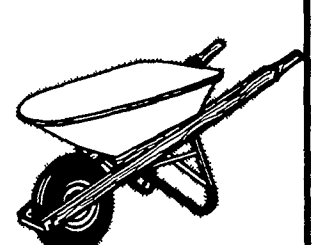

4 Cubic Foot Wheelbarrow

\$37.88

A heavy-duty item with hundreds of uses. Seamless tray. #92854

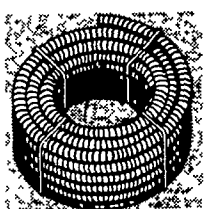

4" Corrugated Drain Pipe

Tough, flexible plastic. Won't corrode. 250' coil. No. 24112

19¢ Ft.

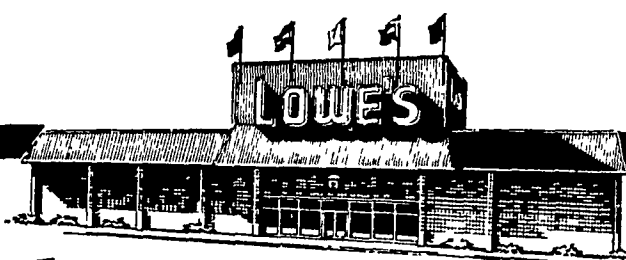

the Farmers' Market

Lancaster
1107 Enterprise Rd.
E. Petersburg
717-299-6630

MON. & FRI. - 8 to 8
TUES., WED., THURS. - 8 to 5:30
SAT. - 8 to 4

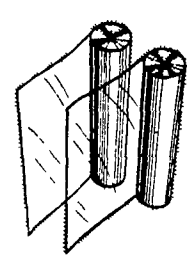

10 Ft. x 25' Polyethylene
\$4.44
Roll

This plastic covering keeps any area dry and protected. Hundreds of uses. #16925